

---

**LIST OF APPENDICES**

Appendix	1:	Luxembourg CAT II ILS DME RWY 24 (Jeppesen Chart)	69
Appendix	2:	CVR Transcription	70
Appendix	3:	FDR graphics	92
Appendix	4:	ATC transcription	96
Appendix	5:	Service bulletin ABSC N° Fo50-32-4, revision 1	102
Appendix	6:	Service letter 137, Fokker Aircraft B.V.	110
Appendix	7:	Service bulletin Fokker Services B.V. N° F50-32-035	115
Appendix	8:	Airworthiness directive LUX-2002-001	118
Appendix	9:	AOF 50.028, Fokker Services B.V.	120
Appendix	10:	Service bulletin Fokker Services B.V. N° F50-32-038	123
Appendix	11:	Service bulletin ABSC N° Fo50-6004125-32-01	128
Appendix	12:	Fokker Services B.V. MCNM-50-045	132
Appendix	13:	Airworthiness Directive LUX-2003-001	134
Appendix	14:	RVR values	136
Appendix	15:	Excerpts from Luxair AOM – Low visibility operations	138
Appendix	16:	Horizontal plot of the trajectory	142
Appendix	17:	Vertical plot of the trajectory	146
Appendix	18:	CVR supplementary analysis	148
Appendix	19:	Excerpts from Luxair AFM	172
Appendix	20:	Airworthiness Directive of the Netherlands BLA nr. 2003-091	174
Appendix	21:	Excerpts from JAR 25.1155	176
Appendix	22:	Fokker Services B.V. comments	179

# APPENDIX 1

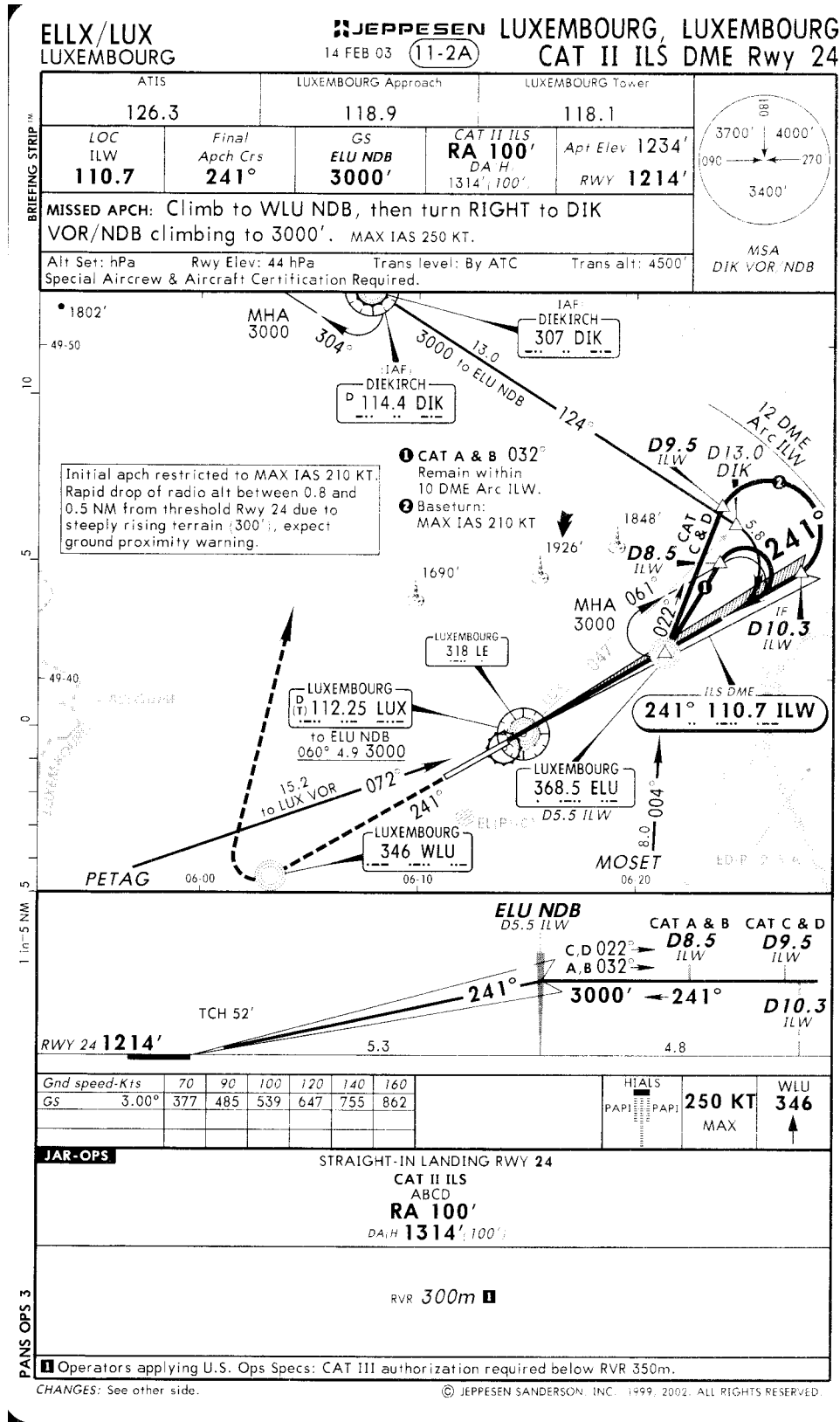

## **Appendix 2**

UTC time	Captain	Co-pilot	ATC	Noises, translation or explanations
08 h 33 min 49 till 08 h 35 min 14	I'm OFF Number one			<b>START OF RECORDING</b>
08 h 35 min 15			<i>ATIS: Visibility one hundred meters, RVR two five zero meters, no change, fog</i>	<i>Conversation irrelevant to the flight</i>
08 h 35 min 28		Two five zero meters ...ech muss awer hém, kaka mâchen goen et ass net méi fir lang hei ze holden		Two five zero meters...but I have to go home to relief myself <i>it is not to stay in the holding for long</i>
08 h 36 min 00		Oh yo		<i>Oh yes</i>
08 h 36 min 01 till 08 h 37 min 29				<i>Conversation irrelevant to the flight</i>
08 h 37 min 30			Luxair nine six four two contact Radar on one two four decimal four seven, Tschüss	
08 h 37 min 35		One two four point four seven, nine six four two, tschau		
08 h 37 min 46		Frankfurt Radar; Hello; Luxair nine six four two, flight level one eight zero, just overhead Mabob, Pemax next		
08 h 37 min 53			Luxair nine six four two, Frankfurt Radar, hello, identified	
08 h 37 min 57 till 08 h 41 min 06				<i>Conversation irrelevant to the flight</i>

UTC time	Captain	Co-pilot	ATC	Noises, translation or explanations
08 h 41 min 07		Hei, esch huelen hei zeréck		<i>Here, I take it back here</i>
08 h 41 min 08			Nine six four two, proceed direct Kirn, and descend flight level one four zero	
08 h 41 min 15		Direct Kirn, and descending flight level one four zero, Luxair nine six four two		
08 h 41 min 25				<i>Conversation irrelevant to the flight</i>
till 08 h 44 min 29				
08 h 43 min 02		Speed		
08 h 44 min 19			Luxair, nine six four two, contact Radar one two five decimal six	
08 h 44 min 22		Two five six, nine six four two, tschau		
08 h 44 min 29		Radar Hallo, Luxair, nine six four two, descending flight level one four zero, on course to Kirn		
08 h 44 min 35			Luxair, nine six four two, Frankfurt Guten Tag, identified, I call you back for further descend, set course direct to Echo Lima Uniform	
08 h 44 min 42		Direct Echo Lima Uniform, and we standby, Luxair, nine six four two		

UTC time	Captain	Co-pilot	ATC	Noises, translation or explanations
08 h 44 min 46		Ech huelen nach eng Kéier dât leschten Wieder, huh, mussen nach a bessen schaffen.		<i>I will check one more time the latest weather, huh, have still to work a little</i>
08 h 44 min 53	Scheisse		<i>Listening to Luxembourg ATIS: 0820 wind calm visibility 100 RVR 250 meters no change overcast 100 temperature 4 Dew point 4 no change</i>	<i>Shit</i>
		Et ass nach emmer calme		<i>It is still calm</i>
08 h 45 min 04		No change		
08 h 45 min 08		Dât dot geseit schlecht aus, mei Jong		<i>This looks bad, my son</i>
08 h 45 min 10	De Pap schafft nach mat allen Tricken			<i>Dad still works with all the tricks</i>
08 h 45 min 12	Waa mir elo den eischten sinn, a wann kén mat CAT drei hannert eis kennt, dann....			<i>If we are now the first one and if nobody follows us with CAT III, then...</i>
15		É moment,	<i>Listening to Luxembourg ATIS: QNH 1023 transition level 50 Cat two Cat three in operation, latest RVR will be given on the ATC frequency Observation ROMEO...</i>	<i>One moment,</i>
08 h 45 min 40		Gutt, zereck		<i>Good, back</i>
08 h 45 min 45		Du wolls eppes verzielen vun enger CAT zwé, oder wât?		<i>You wanted to tell something about CAT II, or what ?</i>

UTC time	Captain	Co-pilot	ATC	Noises, translation or explanations
08 h 45 min 47				C – chord
49		One to go ASEL		
51	Yo, Merci			<i>Yes, Thank you</i>
53	Nee, esch wees net wann et zwee honnert fönnef a siventzesch meter sinn, oder irgend eppes esou, froe mir vir an den Holding ze goen ELU drei dousent fouss, so bâl et drei honnert meter get, könne mir direkt... <i>(unintelligible word)</i> De problem ass, wann et zwé honnert fönnef a siventzech ass an du bass hei am Holding, an hien seet Ok, drei honnert, da fängst du un, an da get et irgenwéi ennerwé zwé honnert fönnef a siventzech, an da bass du schon erem gefullt			<i>No, I don't know if there are 275 m, or something like that, we will ask to go into the holding ELU 3000 feet, as soon as it goes to 300 m, we can go directly... (unintelligible word)</i>  <i>The problem is, if it is 275 m and you are in the holding, and he says OK, 300, then you start and somehow on your way it changes back to 275, then you are screwed again</i>
08 h 46 min 08		Yo		<i>Yes</i>
08 h 46 min 10		Et ass awer zwé honnert foffzech		<i>But it is 250</i>
11	Yo, nén, um ATIS as et zwé honnert foffzech			<i>Yes, no, on the ATIS it is 250</i>
12		Yo, Yo		<i>Yeh, yeh</i>
14	Karayuu !			<i>Exclamation!</i>
18		Fönnef honnert fouss dén ass dann bei siwenzeng honnert zwanzech, hee,		<i>500 feet, he is then at 1720, huh</i>

UTC time	Captain	Co-pilot	ATC	Noises, translation or explanations
21	Huess du de Leit schon eppes gesôt?			<i>Did you say something already to the people?</i>
22		Wât?		<i>What?</i>
	De Leit, hues du denen schon eppes gesôt?			<i>The people, did you tell them already something?</i>
23		Né		<i>No</i>
26	Dât muss du awer nach maan			<i>You still have to do that</i>
27		Wéi? Ech muss guer neischt!		<i>What? I have to do nothing!</i>
30	Wât? Muss du neischt?			<i>What? You must nothing?</i>
33		Du flitts		<i>You fly</i>
34	Nén, mé du mechs de Radio			<i>No, but you do the radio</i>
35		Soll ech de Leit eppes zielen, Ok		<i>Shall I tell something to the people, Ok</i>
36	Yo, du mechs de Radio			<i>Yes, you do the radio</i>
38		Ok		<i>Ok</i>
39	..Starker Nebel, es wird ne harte Landung..			<i>.. heavy fog, it will be a hard landing..</i>
43		Wât, soll ech de Leit da verzielen?		<i>What shall I say to the people ?</i>
45	Ech wéss et net			<i>I don't know</i>
46			Luxair nine six four two, descend flight level one hundred	
50		Descend flight level one		



UTC time	Captain	Co-pilot	ATC	Noises, translation or explanations
08 h 47 min 05		hundred, Luxair, nine six four two		<i>What shall I say then to the people; that it is foggy?</i>
08h 47 min 06	Ma wéi d'Wieder ass, starker Nebel, bla, bla, bla, wann et da schief gét, könne mir soen, sorry, an dann soen ech souwisou eppes, wann et schief gét	Wât soll ech de Leit da verzielen; Et wir Niwel?		<i>Well what the weather is like, heavy fog, bla, bla, bla, if it turns bad then, we can say, sorry, and then I will say something anyway, if it turns bad</i>
13		Yo		<i>Yes</i>
17		Soll ech et net elo verzielen datt mir velleicht eventuell e bessen delai kré'en dodurch?		<i>Shall I not tell them already now that we might get some delay because of that?</i>
21	Yo, kanns du hinnen soen			<i>Yes, you can tell them that</i>
27	Yo, so hinnen dât			<i>Yes, tell them that</i>
32	Wârt, esch ruffen den Dispatch emol, OFF Number one			<i>Wait, I call Dispatch again, OFF number one</i>
34		Yo		<i>Yes</i>
39	Dispatch; moien, neng secks veier zwé,			<i>Dispatch, good morning, 9642</i>
45			<i>Dispatch: Neng secks veier zwé, gudde Moien,</i>	<i>Dispatch: 9642, good morning</i>
47	Yo, normaler weis, ann zeng minuten bis eng vierel Stonn			<i>Yes, normally in 10 minutes to a quarter of an hour</i>
51			<i>Dispatch: Yo, dât wir dann fir de Bravo veier</i>	<i>Dispatch: Yes, it will be then Bravo four</i>

UTC time	Captain	Co-pilot	ATC	Noises, translation or explanations
54	Bravo veier, wéi geseit et aus mam Wierder momentan?			<i>Bravo four, how is the weather for the moment ?</i>
57			<i>Dispatch: RVR zwé honnert fofzech am moment</i>	<i>Dispatch: RVR 250 for the moment</i>
08h 48 min 02	Ann, varierert dât dann oder ass et schons lîng esou?			<i>And, is that changing or has it been like that for long?</i>
06			<i>Dispatch: Also, ehh, et ass schons eng gutt Zeit datt et net méi drei honnert gewisen huet, an, ehh, bon.</i> <i>Komm mir kucken an dann wann wirklech neischt ass, an Saarbrecken ass anderrei, da gess de op Saarbrecken diverteiert.</i>	<i>Dispatch: Well, ehh, it has been quite a while that it did not show 300, and, ehh, well</i> <i>Lets see, and if there is really nothing and Saarbrücken is good, then you will be diverted to Saarbrücken</i>
21	Ok, merci, bis geschwönn			<i>Ok, thank you, until later</i>
25	Yo, esch sinn erem do			<i>Yes, I am back</i>
28	Wârt, ech maan			<i>Wait, I will</i>
29	Ah, Dispatch nach eng Ké'er, vum neng secks veier zwé			<i>Ah, Dispatch once more from 9642</i>
33			<i>Dispatch: Neng secks veier zwé</i>	<i>Dispatch: 9642</i>
35	Dir west net zoufallecher Weis of villeicht eng Cargolux oder esou irgentwann eng kéi'er eraus gét, oder esou?			<i>You don't know eventually if perhaps a Cargolux, or something like that, will leave any time or so?</i>
41			<i>Dispatch: Wât?</i>	<i>Dispatch: What?</i>

UTC time	Captain	Co-pilot	ATC	Noises, translation or explanations
42	Op eng Cargolux takeoff mecht an nächster Zukunft?			<i>If a Cargolux takes off in the near futur?</i>
48			<i>Dispatch: Yo, elo, elo gét eng eraus, he</i>	<i>Dispatch: Yes, now, now there is one leaving, he</i>
52	Elo an a puer Minuten oder elo direkt?			<i>Now in a few minutes or immediately?</i>
55			<i>Dispatch: Elo, si mecht elo takeoff</i>	<i>Dispatch: Now, they now take off</i>
57	Ah, Ok			<i>Ah, Ok</i>
08 h 49 min 07	Et ass schon l�ang keng drei honnert meter m�ei			<i>It is quite a while that there was 300 m</i>
10		Wivill ass et dann elo?		<i>How much is it now?</i>
13			Nine six four two, descend flight level six zero	
14		Descending flight level six zero, Luxair nine six four two		
25	Oh n�en, mir gin zwar, ech gin net op Saarbr�ucken			<i>Oh no, we go however, I will not go to Saarbr�ucken</i>
31		Ech sinn bei de Leit, he!		<i>I am with the people, he!</i>
33			<i>Listening to Saarbr�ucken ATIS until 08 h 50 min 36: Wind 1104 knots, visibility 2000 meters- few 200- broken 600 feet- temperature 2.6- QNH 1024- trend becoming visibility 3000 meters- broken 800 feet- expect ILS approach</i>	

UTC time	Captain	Co-pilot	ATC	Noises, translation or explanations
08 h 50 min 41			<i>RWY 27- transition level 60- Wind 1104 knots- visibility 2000</i>	
48		Stop descend nine zero, direct Diekirch, Luxair nine six four two	Luxair, nine six four two; on request from Luxembourg, stop your descend at flight level nine zero, set course to Diekirch	
08h 51 min 42		Zereck; ech muss mer elo mol, wât ech de Leit soll zielen, dât ass emmer esou schwéier, ech hât dén Fall elo schon lîng net méi		<i>Back; I have now to, what I should tell the people, it's always so difficult, it has been a long time since I had this situation</i>
54		Ehh		<i>Ehh</i>
58		Ehh, wéi ass d'Wieder iwerhâpt? Niwelech, déif Wolleken		<i>Ehh, how is the weather anyway? Foggy, low clouds</i>
08 h 52 min 15			Luxair, nine six four two, for lower and Radar vectors contact Luxembourg one one eight decimal nine	
21		Ehh, one eight decimal nine, Luxembourg, nine six four two, bye, bye		
26		Kucken wât déi elo soen		<i>Lets see what they now say</i>

UTC time	Captain	Co-pilot	ATC	Noises, translation or explanations
41		Luxembourg Radar, gudde Moien, Luxair nine six four two, descending level nine zero, on course to Diekirch		Luxembourg Radar, good morning, Luxair nine six four two,.....
49			Luxair, nine six four two, enter Diekirch holding, flight level nine zero, it will be vectors later on for ILS two four Cat two on two four, QNH one zero two three, current RVR beginning two five zero meters, mid two seven five meters, stop end two two five meters	
08 h 53 min 06		That's all understood, Luxair nine seven, correction nine six four two		
20	Wéi? One hundred for six zero, dat héscht dé gét elo durch eis Héicht			<i>What? One hundred for six zero, that means he passes through our height.</i> [Captain refers to an ATC clearance given to another aircraft]
24		Ech sinn bei de Leit elo, he		<i>I am with the people now, he</i>
36		Ladies and gentlemen, good morning from the cockpit your first officer. Well the latest news from Luxembourg. The weather is for the moment very foggy and the temperature 4°. Unfortunately the fog is so dense that eh, at		[Co-pilot gives passenger info on public address until 08 h 56 min 31. Languages used: Luxembourg, then German and finally English]

UTC time	Captain	Co-pilot	ATC	Noises, translation or explanations
08 h 54 min 43	Luxair, nine six four two is reducing speed to one six zero	the moment we cannot land, so we have to wait a little bit for improvement, so that means that we are proceeding to a holding and to wait for weather improvement. Anyway we keep you informed as soon as we have some news and the time it might take for the weather to improve. Thank you for your attention.		
49			Roger, nine six four two	
08 h 56 min 34	Yo, Yo, dat war awer wirklesch Pech, ehh, Cargolux gét elo reischt eraus, wann se eis direct goen			<i>Yes, yes, it was really a pity, eh, Cargolux leaves only now, if they had let us directly</i>
38		Yo		<i>Yes</i>
44	goen geloost hätten, da wiren mer elo just richte gewiercht			<i>let us go directly, then we would have been just right</i>
		Paula ? hun ech net zevill egal wât geschwart ? Alles OK ? Merci. Et ass alles ok, et ass just wénst dem Niwel. Wann d'Wieder elo besser get, et félt net vill, et félen 25 meter, wann mir déi hunn, dât misst goen, ok, tschau		<i>[Call to cabin crew] Paula ? Didn't I talk nonsense ? Everything ok ? Thank you. Everything is ok, it is only because of the fog. If the weather gets better now, its not missing a lot, we miss 25 meters, once we have those, it should be ok, bye</i>

UTC time	Captain	Co-pilot	ATC	Noises, translation or explanations
51				[Co-pilot talks to cabin crew until 08 h 57 min 22]
08 h 57 min 31	Verflixt namol!			<i>Damn it !</i>
34	Dât wir wierklech ze vill schéin gewierscht vir eng Kéier mat der Cargolux			<i>It would have been really too nice to be able for once with Cargolux</i>
40		Established on the LOC (*)		
44	Swissair ass wierklech optimal elo (*)			<i>Swissair is really optimal now(*)</i> [The crew refers to another aircraft]
55	Se hätten eis sollen do hannen drunn hänken, blöd approche do			<i>They should have hooked us behind them, silly approach</i>
08 h 58 min 12	Se hun all net esou vill Spritt wéi mär hunn. Mär hun getankt, mé léiwen Jong, vir den (unintelligible word)			<i>They all don't have as much fuel as we have. We have filled up, my dear son, for the (unintelligible word)</i>
20		Mir können holden bis d'Pei		<i>We can hold until pay day</i>
23		Bis wéni, bis wivill Auer könne mer iwerhâpt holden, wât brauchen mer iwerhâpt vun Sprit?		<i>Until when, until what time can we hold anyway, what do we need as fuel anyway?</i>
26	Ehh, Fönnef honnert fofzech, ehh, sieven..... sieven honnert, né, achthonnert fofzech mussen mer hun nach wa mer den Holding verlossen			<i>Eh, 550, eh, seven..seven hundred, no, we need 850 when we leave the holding</i>
38		Wéi? Alternate drei honnert		<i>How? Alternate 300</i>
39	Dât héscht, mer können fönnef			<i>That means, we can burn 550 kilos here</i>

UTC time	Captain	Co-pilot	ATC	Noises, translation or explanations
43	honnert fofzech kilo verbrennen hei	Né, mir brauchen bis op den Alternate plus nach eng kéier zwanzech Minuten Reserve fir eng hallef Stonn erem hei, secks honnert Kilo brauchen mir der nach.		<i>No, we need until the alternate plus 20 more minutes reserve for half an hour back here, 600 kilos we still need</i>
48	Yo, mé ech hålen den Holding awer och gär dofir			<i>Yes, but I like keep the holding also for that</i>
50			Luxair, nine six four two, descend to three thousand feet on one zero two three, turn left heading one three zero	
57		Ass dat fir eis?		<i>Is that for us?</i>
58	Yo			<i>Yes</i>
59		Descend three thousand feet on QNH one zero two three and say again the heading?		
08 H 59 min 06			One three zero	
08		Left heading one three zero, Luxair, nine six four two		
13		Wât ass dât dann fir a scheiss		<i>What kind of shit is that</i>
35	Wéi ass d'RVR dann elo?			<i>What is the RVR now?</i>
37		Ech wéss et net		<i>I don't know</i>
49		Ech hun normal NAV		<i>I am on normal NAV</i>



UTC time	Captain	Co-pilot	ATC	Noises, translation or explanations
50	Wât war den QNH? One zero			<i>What was the QNH? One zero</i>
51		Two three		<i>Two three</i>
59	Solle mer net elo den Dispatch froen wât d'RVR ass?			<i>Shouldn't we ask Dispatch now, what the RVR is now?</i>
09 H 00 min 01		Dach		<i>Yes</i>
02		Mechs du dât elo? Oder soll ech et mâchen?		<i>Do you do it now? Or, shall I do it?</i>
04	One two six decimal three sin mer, neen one three one decimal six two			<i>We are 126.3, no 131.62</i>
09		Correct		<i>Correct</i>
19	Ech sin nach eng Kéier OFF nummer eent			<i>I am OFF number one again</i>
20		Yo		<i>Yes</i>
22	Dispatch, nine six four two nach eng Keier			<i>Dispatch, 9642 again</i>
	Wéi fill de Moment d'RVR?		<i>Dispatch: 9642 go ahead</i>	
	Ok		<i>Eh, 275</i>	
38	Zwee sieven fönnef meter nach, wât machen mer elo?			<i>275 meters, what do we do now?</i>
41		Ech wéss et net		<i>I don't know</i>
50			[ATC transmits RVR] beginning 275, mid section	

UTC time	Captain	Co-pilot	ATC	Noises, translation or explanations
09 H 01 min 06		Yo, wât mâchen si dann mat eis, holding oder ass dât do fir eng approche?	275, stop end 225 meters to Luxair eight three six two	<i>Yes, what do they do with us then, holding or is it for an approach?</i>
09 15	Dât ass fir eng approche	So d' Cargolux soll én go-around mâchen zu Letzeburg		<i>It's for an approach</i> <i>Tell Cargolux to do a go-around in Luxembourg</i>
16	Wât?			<i>What?</i>
17		Se sollen a go-around mâchen		<i>They should do a go-around</i>
19	Né se sinn reischt take-off gemâch			<i>No, they just made a take-off</i>
21		Maja, se sollen eng Schleif mâchen an dann a go-around an dann mâchen se alles frei, an dann sssst		<i>Yes, they should make a circuit and then a go-around and then they clear up everything, and then sssst</i>
09 h 01 min 25			Niner six four two turn right heading two two zero to intercept cleared for approach report established on the localizer	
09 h 01 min 31		Right heading two two zero. and euh cleared approach... and we call you established on the localizer nine six four two		
09 h 01 min 42		Oh freck, da ginn mir nach virun all Mensch geholl hei		<i>Oh gosh, they bring us in before all the others</i>

UTC time	Captain	Co-pilot	ATC	Noises, translation or explanations
09 h 01 min 43	He			
09 h 01 min 44		Mir gi nach virun jidwerengem virgeholl hei		<i>They bring us in before everybody</i>
09 h 01 min 58		Solle mer de seat belt umâchen?		<i>Should we switch on the seat belt?</i>
09 h 02 min 00	Yo yo dât wier villeicht net schlecht			<i>Yes Yes this wouldn't be a bad idea</i>
09 h 02 min 02	Mir müssen hei fir d'approche ehhhh			<i>We must here for the approach ehhhh</i>
09 h 02 min 04	100 Fouess			<i>100 feet</i>
09 h 02 min 07		Yo, ech hun dât schon dran		<i>Yes, I already dialled that in</i>
09 h 02 min 09	LOC ass alive an captured			<i>LOC is alive and captured</i>
		Checked Missed approach heading		
09 h 02 min 12	So him, ech geng villeicht beschéd soen färer Weis dass wa mer bei Echo keng 300 meter hun, dass mer dann e go-around machen an op Dikrech fléen			<i>Tell him, I would rather say as a matter of fairness, that if at Echo we don't have 300 meters, that we then do a go-around and fly to Diekirch</i>
09 h 02 min 32		The Lux euh nine six four two is now established on the localizer		
09 h 02 min 37			Luxair niner six four two contact tower on one one eight decimal one, äddi	<i>Äddi = goodbye</i>
09 h 02 min 41		Eighteen one nine six four two		<i>Äddi = goodbye</i>

UTC time	Captain	Co-pilot	ATC	Noises, translation or explanations
09 h 02 min 51		, äddi Turm, gudden Moien Luxair nine six four two is established I L S two four		<i>Tower, good morning.....</i>
09 h 02 min 52				Noise resembling a seat movement
09 h 02 min 57			Luxair nine six four two gudden Moien, continue approach. The wind is calm R V R beginning two five zero meters, mid section two five zero meters, stop end two two five meters	<i>Gudden Moien = good morning</i>
09 h 03 min 04	Oh, dat brengt neischt			<i>Oh, this doesn't bring a thing</i>
09 h 03 min 07	Oh, dat brengt neischt			<i>Oh, this doesn't bring a thing</i>
09 h 03 min 08		Euh... that's copied Luxair nine six four two... but euh we need three hundred meters for the approach		
09 h 03 min 16	So, mir gin weider fir bis ELU, wa mir dann neischt hätten, dann ehhhhhh			<i>Say, we continue up to ELU, if then we have nothing, then ehhhhh</i>
09 h 03 min 18		Yo	Nine six four two copied... euh so continue approach and I'll keep you advised we didn't have three hundred euh... euh during the last time	<i>Yes</i>
09 h 03 min 26	Oh			
09 h 03 min 28		Euh Roger nine six four two we keep you advised we're proceeding to ELU now and ...euh standing by nine six		C chord

UTC time	Captain	Co-pilot	ATC	Noises, translation or explanations
09 h 03 min 38		four two	Roger... and euh we have ehhh zero degrees wind	
09 h 03 min 42		Roger		
09 h 03 min 43			...schen , zero knots	
09 h 03 min 44		Roger		
09 h 03 min 52	Hä			<i>Exclamation (questioning)</i>
09 h 04 min 09	Sou, si mer de beacon, he nach net grât En ass 5,5 DME			<i>Now, are we beacon, hey not yet</i>
09 h 04 min 16		Da muss é mol e beacon setzen, mei Jong		<i>It is 5,5 DME</i>
09 h 04 min 18	Yo, mé ech hun jo en DME			<i>Then one must select a beacon first, lad</i>
09 h 04 min 19		Ye Ye Ye		<i>Yes, but I do have a DME</i>
09 h 04 min 23		Ye Ye Ye		<i>Laugh</i>
09 h 04 min 25	Laugh			
09 h 04 min 30		ASEL		
09 h 04 min 33		Three thousand sixty top		
09 h 04 min 35	Checked			
09 h 04 min 36		Landing altitude and briefing completed, altimeters euh set		
09 h 04 min 40		Speed ninety five one oh five one oh nine Landing altitude		

UTC time	Captain	Co-pilot	ATC	Noises, translation or explanations
09 h 04 min 43	Two seven five meters			
09 h 04 min 44		set		
09 h 04 min 46	Yo, bon mir mâchen en go-around, missed approach			<i>Yes, well we do a go-around, missed approach</i>
09 h 04 min 53		Ground idle stop off		
09 h 04 min 57			Luxair nine six four two RVR three hundred meters two seven five meters ... stop end two seven five meters	
09 h 04 min 58				Noises identified to probably be the displacement of the Ground Idle Stop
09 h 05 min 00				Variation of the turbine rotational speed
05 min 00				Noises identified to be the lifting of the Ground Range selectors
05 min 02		gét net duer		<i>will not be enough/sufficient</i>
05 min 05		Nine six four two roger so we continue		
05 min 07		Flaps?		
05 min 08	Oh mir sin ....flaps ten		Nine six four two you're cleared to land wind one eight zero degrees (unintelligible) knots	<i>Oh we are... flaps ten</i>
05 min 09 s 10				Noise identified to be the moving of the flap selector
05 min 11 s 20				Noise identified to be selecting Taxi Light

UTC time	Captain	Co-pilot	ATC	Noises, translation or explanations
05 min 11 s 80		Gear down?		
05 min 12 s 70	Ya			
05 min 13 s 60		Clear to land nine six four two		
05 min 16 s 10				Noise similar to selecting gear down followed by gear extension noises
05 min 16 s 60		Dât do gett zwar....		<i>This will rather be.....</i>
05 min 17 s 70				Increase of propeller speed
05 min 19 s 40				Noise identified to be the power levers passing through the ground idle position <i>What's that ?</i>
05 min 21 s 20	Wât ass dât			Noise similar to flaps selection (no identification possible)
05 min 21 s 60				Noise similar to a propeller speed variation
05 min 22 s 80	Hä			Exclamation (questioning)
05 min 22 s 90	Oh merde			<i>Oh shit</i>
05 min 23 s 40				Noise similar to electric transfer
05 min 23 s 70				Single Chime
05 min 26 s 20				Noise similar to a propeller speed reduction
05 min 27 s 00				Noise (no identification possible)
05 min 27 s 70				Start of GPWS alarm « Terrain »

UTC time	Captain	Co-pilot	ATC	Noises, translation or explanations
05 min 28 s 00				Recording stops (1/3 s)
05 min 28 s 30		Bo dât war awer eng lenk		<i>Wow this was shrewed stuff</i>
<i>Non validated time</i>				The recorded portion from 05 min 28 s 00 until the noise of electric transfer at 05 min 28 s 90 is a recorded portion from the beginning of the CVR and not newly overwritten
05 min 28 s 90				Noise similar to electric transfer
<i>Non validated time</i>				
05 min 29 s 10	Oh merde	Heavy breathing		<i>Oh shit</i>
<i>Non validated time</i>				
05 min 40 s 10				Restart of recording. The recorded portion from 05 min 40 s 10 until the noise of electric transfer at 05 min 40 s 80 is a recorded portion from the beginning of the CVR and not newly overwritten.
05 min 40 s 80				Noise similar to electric transfer
05 min 41 s 60			Ready for push back next, Mike Kilo Alpha one two three	
05 min 41 s 90				Double Chime (two single Chimes separated by 0.7 seconds)
05 min 44 s 60				<b>End of recording</b>



## **Appendix 3**

# LX-LGB

Fokker 27-Mk050, Luxair

6/11/2002, Luxembourg

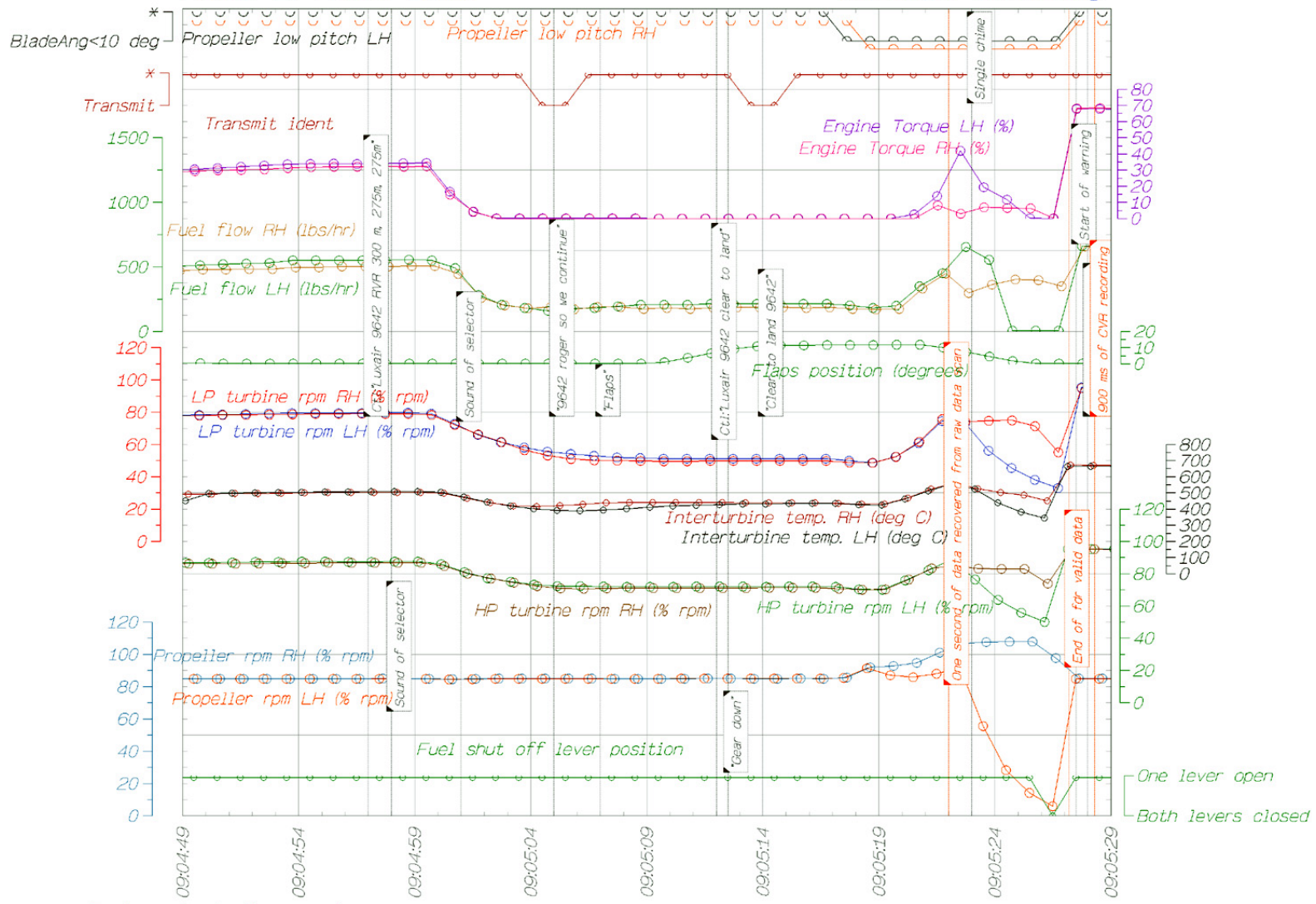

Engines, last 40 seconds

UTC time

BEA - Departement Technique

# LX-LGB

Fokker 27-Mk050, Luxair

6/11/2002, Luxembourg

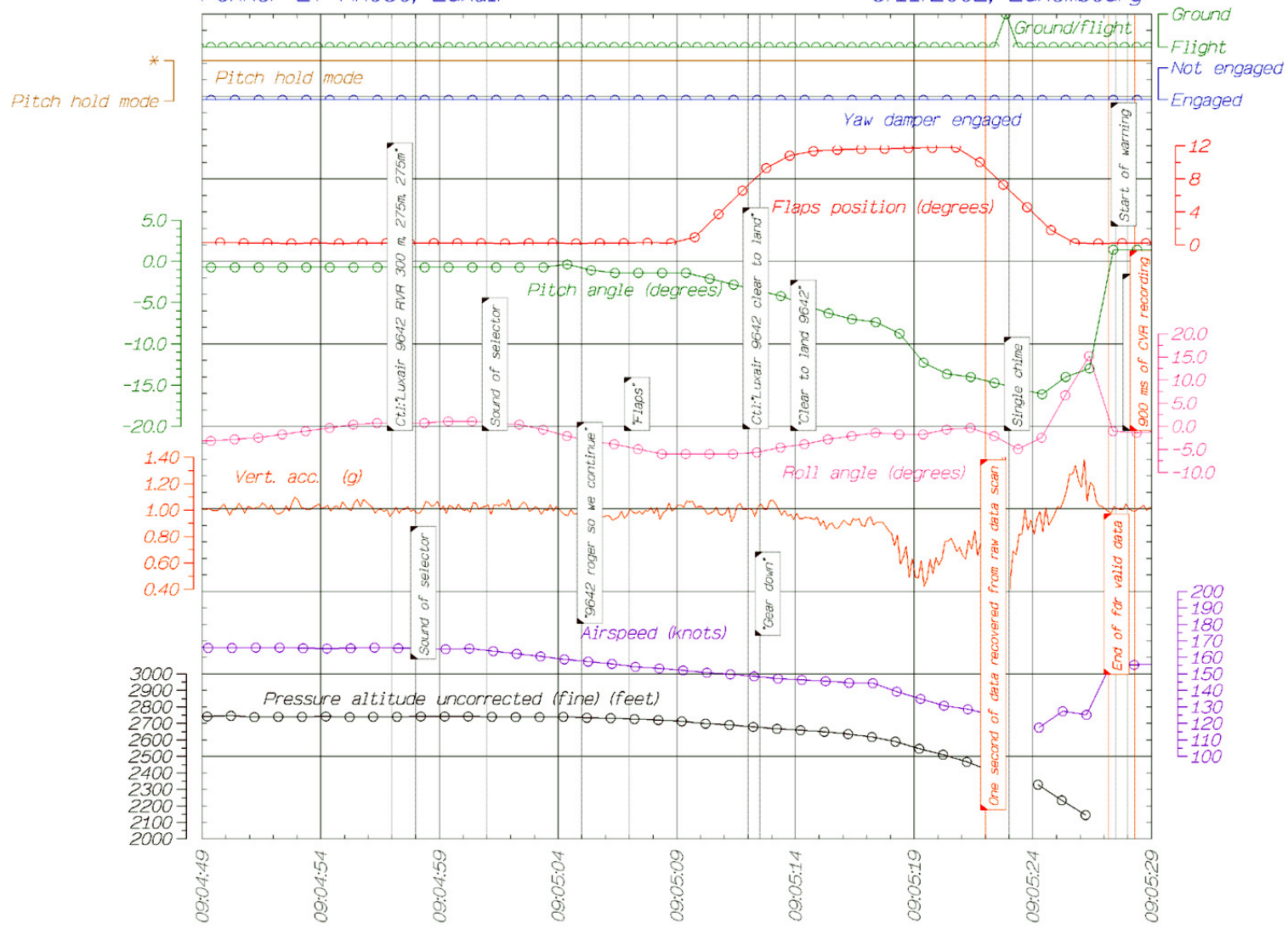

General parameters, last 40 seconds

UTC time

BEA - Departement Technique

# LX-LGB

Fokker 27-Mk050, Luxair

6/11/2002, Luxembourg

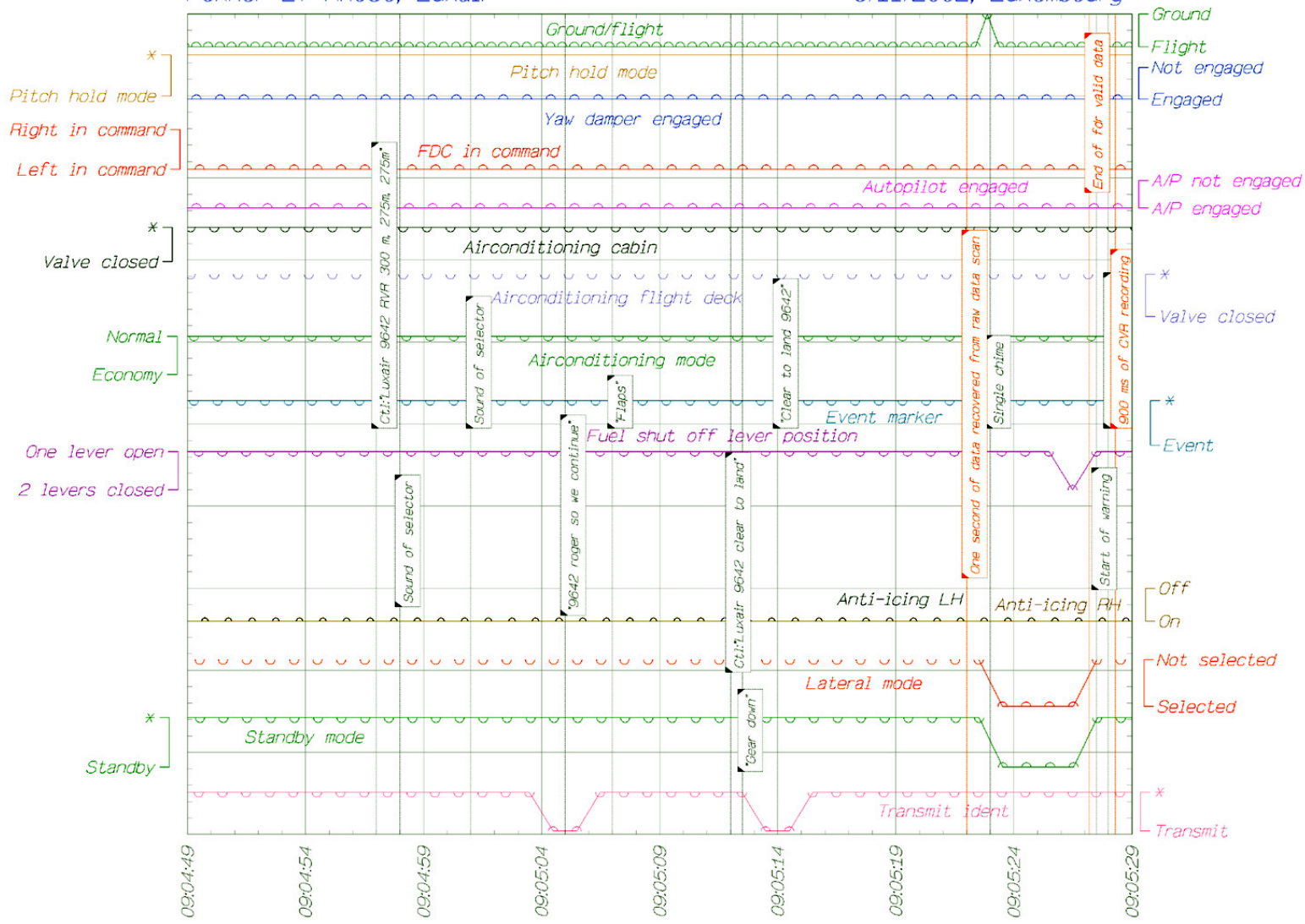

Discrete parameters, last 40 seconds

UTC time

BEA - Departement Technique

## **Appendix 4**

## Transcript of Original Tape Recording

### Approach radar control unit

#### Frequency 118.900

Time in UTC	From	To	Communications
08:52:38	LGL9642	APP	Luxembourg Radar gudde Muergen Luxair nine six four two, descending flight level nine zero, uh, on course to..., Diekirch.
08:52:47	APP	LGL9642	Luxair niner six four two enter Diekirch holding at flight level niner zero it will be vectors later on for an I_L_S approach category two on two four. Q_N_H is one zero two tree current R_V_R beginning two five zero on mid section two seven five, stop end two two five.
08:53:05	LGL9642	APP	That's all understood, uh, Luxair nine seven, correction nine six four two.
08:53:10	LGL402	APP	Uh, Luxair four zero tree is entering Diekirch hold, passing one hundred for six zero.
08:53:15	APP	LGL402	Roger four zero two.
08:53:26	LGL9302	APP	Luxair nine tree zero two are we cleared to land?
08:53:30	APP	LGL9302	Luxair nine tree zero two is cleared for approach, for landing contact tower one one eight one, bye bye.
08:53:36	LGL9302	APP	One one eight one, Luxair nine tree four two, bye.
08:54:44	LGL9642	APP	And Luxair nine six four two is reducing speed to one sixty.
08:54:47	APP	LGL9642	Roger nine six four two.
08:56:01	LGL4452	APP	Luxair four four five two entering hold Diekirch flight level nine zero.
08:56:05	APP	LGL4452	Roger four four five two.
08:56:15	APP	SWR750	Swiss seven five zero turn left heading tree tree zero base leg.
08:56:20	SWR750	APP	Left heading tree tree zero base leg, Swiss seven five zero.
08:56:45	APP	SWR750	Swiss seven five zero turn left heading two seven zero to intercept the localizer, report established on the loc.
08:56:51	SWR750	APP	Left heading two seven zero to intercept the localizer, we'll report established on the loc, Swiss seven five zero.
08:57:37	SWR750	APP	Established on the loc Swiss seven five zero.
08:57:39	APP	SWR750	Roger, Swiss seven five zero continue your approach, the sensitive area is not clear yet, we have a seven four seven about to depart.
08:57:47	SWR750	APP	Okay, we continue the approach in this case, Swiss seven five zero.

08:57:56	LGL8362	APP	Luxair eight tree six two entering Diekirch holding, flight level eight zero time five seven.
08:58:01	APP	LGL8362	Roger, eight tree six two.
08:58:14	LGL4452	APP	And approach, for info, Luxair four four five two we need two hundred meters for the approach.
08:58:28	APP	LGL4452	Four four five two say again, please.
08:58:30	LGL4452	APP	Uh, just for info, we need two hundred meters for the approach.
08:58:33	APP	LGL4452	Okay no problem.
08:58:35	APP	SWR750	Swiss seven five zero is cleared for the I_L_S category tree contact tower one one eight decimal one, bye bye.
08:58:41	SWR750	APP	One one eight one and cleared for the approach cat tree, Swiss seven five zero, bye bye.
08:58:48	APP	LGL9642	Luxair niner six four two descend to tree thousand feet on one zero two tree turn left heading ...one tree zero.
08:58:57	LGL9642	APP	Descending tree thousand feet on Q_N_H, uh, one zero two tree and say again the heading?
08:59:04	APP	LGL9642	One tree zero.
08:59:07	LGL9642	APP	Uh, left heading one tree zero Luxair nine six four two.
08:59:09	CLX778	APP	Cargolux seven seven eight airborne.
08:59:11	APP	CLX778	Cargolux seven seven eight climb flight level seven zero on runway heading.
08:59:17	CLX778	APP	Runway heading, seven zero, Cargolux seven seven eight.
08:59:23	APP	LGL402	Luxair four zero two report speed.
08:59:27	LGL402	APP	Speed two ten four zero two.
08:59:29	APP	LGL402	Roger four zero two bring it back to one eight zero.
08:59:35	LGL402	APP	Uh, for how long, because otherwise we are burning more fuel, four zero two
08:59:39	APP	LGL402	Uh, that's just to slow you down and then I'll take you out of the hold.
08:59:42	LGL402	APP	Okay no problem, so reducing one eighty, four zero two, merci.
09:00:24	APP	LGL402	Luxair four zero two, descend to tree thousand feet one zero two tree, turn right heading zero nine zero.
09:00:30	LGL402	APP	Roger right heading zero nine zero and down to tree thousand one zero two tree, four zero two.
09:00:40	LGL8362	APP	Approach, uh, eight tree six two, could you confirm our latest R_V_R_.
09:00:46	APP	LGL8362	R_V_R beginning two seven five, mid section two seven five, stop end two two five.
09:00:52	LGL8362	APP	Okay.
09:01:09	APP	CLX778	Cargolux seven seven eight turn right heading zero six zero, climb to

			flight level one two zero.
09:01:17	CLX778	APP	Right heading zero six zero, climb flight level one two zero, Cargolux seven seven fi...seven seven eight.
09:01:21	APP	LGL9642	Luxair niner six four two turn right heading two two zero to intercept. Cleared for approach, report established on the localizer.
09:01:30	LGL9642	APP	Right heading two two zero and, uh, cleared approach and we call you established on the localizer nine six four two.
09:01:38	LGL5432	APP	Luxembourg approach good morning, Luxair five four tree two descending flight level one tree zero to Diekirch, information Sierra.
09:01:44	APP	LGL5432	Luxair five four tree two, uh, gudde Muergen, descend to flight level one hundred enter Diekirch holding, vectoring later on to the I_L_S_ two four, cat two.
09:01:54	LGL5432	APP	Luxair five four tree two descend flight level one hundred enter Diekirch holding for vectors runway two four, uh, how bounds, uh, how much delay do you expect?
09:02:04	APP	LGL5432	Just couple of minutes.
09:02:06	LGL5432	APP	Roger.
09:02:13	APP	CLX778	Cargolux seven seven eight climb to flight level one seven zero.
09:02:18	CLX778	APP	Cleared flight level one seven zero, Cargolux seven seven eight.
09:02:20	APP	CLX778	I have to take you on a, uh, zero six zero heading to get you on top of the Diekirch holding
09:02:27	CLX778	APP	Roger, we are turning right.
09:02:30	LGL9642	APP	Luxair nine six four two is now established on the localizer.
09:02:34	APP	LGL9642	Luxair niner six four two contact tower one one eight decimal one Äddi.
09:02:39	LGL9642	APP	Eighteen one nine six four two. Äddi

### Aerodrome control unit

#### Frequency 118.100

Time in UTC	From	To	Communications
09:02:48	LGL9642	TWR	Tuerm gudde Muergen Luxair nine six four two is, uh, established I_L_S_ two four
09:02:54	TWR	LGL9642	Luxair nine six four two gudde Muergen, continue approach the wind is calm R_V_R beginning two five zero meters mid section two five zero meters stop end two two five meters.
09:03:07	LGL9642	TWR	Uh, that's copied Luxair nine six four two, but we need tree hundred meters for the approach.



09:03:16	TWR	LGL9642	Nine six four two copied, uh, so continue approach I keep you advised. We didn't have tree hundred, uh, during the last, uh, time.
09:03:25	LGL9642	TWR	Uh, roger nine six four two we keep you advised. We're proceeding to Elu now and, uh, standing by, nine six four two.
09:03:35	TWR	LGL9642	Roger and we have, uh, zero degrees wind, uh.
09:03:40	TWR	LGL9642	Correction zero knots.
09:03:43	LGL9642	TWR	Roger.
09:03:45	TWR	SWR750	Seven five zero report entering parking number one please.
09:03:53	TWR	SWR750	Swiss seven five zero report entering the apron.
09:03:57	SWR750	TWR	We report entering the apron, Swiss seven five zero.
09:04:10	MKA123	TWR	Tower, good morning Mike Kilo Alpha one two tree, stand two with Romeo requesting start up please.
09:04:18	TWR	MKA123	Mike Kilo Alpha one two tree good morning, start up is approved, runway in use two four, Q_N_H one zero two tree, confirm you are parking number seven.
09:04:26	MKA123	TWR	Negative, Sir, parking two and we are cleared for start one zero two tree and could you just give us the position of that lowest value of R_V_R, please.
09:04:38	TWR	MKA123	We have now on the tree positions two seven five meters.
09:04:41	MKA123	TWR	Thank you.
09:04:48	SWR750	TWR	Uh, We are entering the apron behind marshaller (garbled transmission).
09:04:59	TWR	LGL9642	Luxair nine six four two R_V_R tree hundred meters two seven five meters stop-end two seven five meters.
09:05:03	LGL9642	TWR	Nine six four two roger, so we continue.
09:05:07	TWR	LGL9642	Nine six four two you are cleared to land, wind one eight zero degrees five knots.
09:05:11	LGL9642	TWR	Cleared to land, uh, nine six four two
09:05:16	TWR	MKA123	Mike Kilo Alpha one two tree Luxembourg (garbled due to simultaneous transmission).
09:05:16	SWR750	TWR	(Unreadable) ... we are at the apron.
09:05:22	MKA123	TWR	Was that for Mike Kilo Alpha one two tree?
09:05:24	TWR	MKA123	That's confirmed, Mike Kilo Alpha one two tree report ready for push back.
09:05:29	MKA123	TWR	Cleared to push, thanks, one two tree.
09:05:31	TWR	MKA123	Mike Kilo Alpha one two tree, I confirm report ready for push back.
09:05:39	MKA123	TWR	Ready for push back next, Mike Kilo Alpha one two tree.
09:05:42	TWR	MKA123	Roger.

09:06:57	TWR	LGL9642	Nine six four two Luxembourg.
09:07:08	TWR	LGL9642	Luxair nine six four two Luxembourg.
09:07:30	TWR	LGL9642	Luxair nine six four two Luxembourg do you read?
09:07:55	TWR	LGL9642	Luxair nine six four two Luxembourg do you read?
09:08:10	TWR	LGL9642	Luxair nine six four two Luxembourg.
09:08:39	TWR	LGL9642	Luxair nine six four two Luxembourg do you read?

The signers certify the completeness and correctness of the present transcript  
Luxembourg Airport 13 November 2002

(s)  
Head of Air Traffic Control  
Luxembourg

(s)  
Deputy head of Air Traffic Control  
Luxembourg

## **APPENDIX 5**

---

**AIRCRAFT BRAKING SYSTEMS**  
Corporation

# SERVICE BULLETIN

TO: HOLDERS OF SERVICE BULLETIN F50-32-4 FOR LANDING GEAR SKID CONTROL SYSTEM - CONTROL UNIT REWORK INSTRUCTIONS

Attached to this transmittal letter is Revision No. 1 of Service Bulletin F50-32-4 (basic issue dated Aug 1/92).

**HIGHLIGHTS OF REVISION NO. 1 DATED 29 JUNE 1994**

REVISION NO. 1 CONTAINS ALL PAGES OF THE SERVICE BULLETIN. Pages which have been revised are outlined below, together with the Highlights of the revision.

1. SECTION I, Page 1 of 6:
  - A. Added Revision No. 1 and date.
  - B. Removed reference to autobrake which was incorrect and added correct statement in the Reason paragraph (paragraph B).
  - C. Removed blank page.
2. Replace Service Bulletin F50-32-4, pages 1 thru 7 with Service Bulletin F50-32-4, Revision No. 1, pages 1 thru 6, revised Jun 29/94.

Jun 29/94

F50-32-4  
Page 1 of 1

# SERVICE BULLETIN

**SUBJECT:** LANDING GEAR SKID CONTROL SYSTEM - CONTROL UNIT REWORK INSTRUCTIONS

## SECTION I - PLANNING INFORMATION

- A. **EFFECTIVITY:** This Service Bulletin is applicable to all Control Unit Assemblies 6004125 used on F27 Mk050 (FOKKER 50) aircraft.
- B. **REASON:** This Service Bulletin is issued to inform operators of the new Control Unit 6004125-1 and provides instructions to modify the 6004125 control unit assembly into the 6004125-1 assembly. The new unit differs from the old only in the addition of one capacitor and one diode, one each per wheel board. These components prevent a condition during power up of the skid control box whereby a signal pulse is inadvertently sent to the ground control relay thus affecting the flight idle stop solenoids.
- The modification does not eliminate any existing test functions. It does not affect the antiskid control functions.
- C. **DESCRIPTION:** The Service Bulletin provides rework instructions for:
- (1) Addition of one capacitor (C76) and one diode (CR10) on each wheel control board.
  - (2) Reidentifying reworked boards and control unit and performing testing at unit bench and aircraft levels.
- D. **COMPLIANCE:** Compliance with this Service Bulletin is to be accomplished at the option and expense of the operator. It is recommended this rework be accomplished when the control unit is removed or being repaired for another reason.
- E. **APPROVAL:** Compliance with this Service Bulletin does not alter FAA TSO conformance.
- F. **MANPOWER:** Eight man-hours (estimated) are required to modify, reidentify and test one control unit. This includes six hours allotted for minimum testing. This estimate does not include the time required to remove, install and test the unit in the aircraft.
- G. **MATERIAL - COST AND AVAILABILITY:** Obtain capacitor and diode locally from best source as required.
- H. **TOOLING:** None.
- I. **WEIGHT AND BALANCE:** None.
- J. **ELECTRICAL LOAD DATA:** Not affected.
- K. **REFERENCE:** AP-647 (32-47-56) Component Maintenance Manual for Skid Control Unit Assembly 6004125 (basic issue dated 14 February 1986), Revision No. 2 dated 21 March 1989.
- L. **OTHER PUBLICATIONS AFFECTED:** None.

Aug 1/92  
Revision No. 1  
Jun 29/94

(RELEASED: \_\_\_\_\_)

Fo50-32-4  
Page 1 of 6

---

**AIRCRAFT BRAKING SYSTEMS**  
Corporation**SECTION II - ACCOMPLISHMENT INSTRUCTIONS**

The following instructions detail the steps required to rework the Control Unit Assembly 6004125 to 6004125-1.

**CAUTION:** PRINTED WIRING BOARDS CONTAIN DEVICES SUSCEPTIBLE TO DAMAGE OR DEGRADATION FROM ELECTROSTATIC DISCHARGE (ESD). HANDLING PRECAUTIONS AND REPAIR PROCEDURES APPLICABLE TO ELECTROSTATIC SENSITIVE DEVICES (ESSD) ARE REQUIRED.

A. Removal of Both Wheel Control Boards

- (1) Release turnlock fastener at the rear of the control unit.
- (2) Remove screw from the top of the control unit assembly and slide chassis subassembly free of cover. Retain the screw and cover until reassembly.

**NOTE:** Note location of subassembly serial number relative to "Inboard/Outboard" card slot location.

B. Rework of Wheel Control Boards

**CAUTION:** POLYURETHANE COATINGS MUST BE THOROUGHLY REMOVED FROM THE AREAS TO BE RESOLDERED OR AN INADEQUATE ELECTRICAL CONTACT WILL RESULT. POSITION COMPONENTS CAREFULLY TO ASSURE ADEQUATE CLEARANCE OF COMPONENT BODIES AND LEADS WITH REGARD TO ADJACENT COMPONENTS.

**NOTE:** For removal and application of urethane coatings, see Replacing Components on Circuit Boards paragraph in referenced Component Maintenance Manual.

- (1) Rework Control Board Subassembly 6004125 into 6004125-1 as follows (See Figure 1):
  - (a) Install Capacitor M39014/02-1411 (C76) and Diode JANTXIN4148-1 (CR10) on the non-component side of board as shown in Figure 1.

**NOTE:** Use Insulation Sleeving B7444-3-2-16B and Hysol 0151 Sealant as required.

- 1 Solder each component to board and trim ends.
- 2 When installing a new component, maintain 0.03 inch (0,76 mm) minimum space between the component and the surface of the board.

**CAUTION:** AVOID CONTAMINATION OF THE BOARD CONNECTOR PINS WITH RESIDUE FROM THE CLEANING AND COATING PROCESSES.

- 3 Clean components and reworked area with Freon TP-35 and allow to dry thoroughly.

Aug 1/92  
Revision No. 1  
Jun 29/94

Fo50-32-4  
Page 2 of 6

**AIRCRAFT BRAKING SYSTEMS**  
Corporation

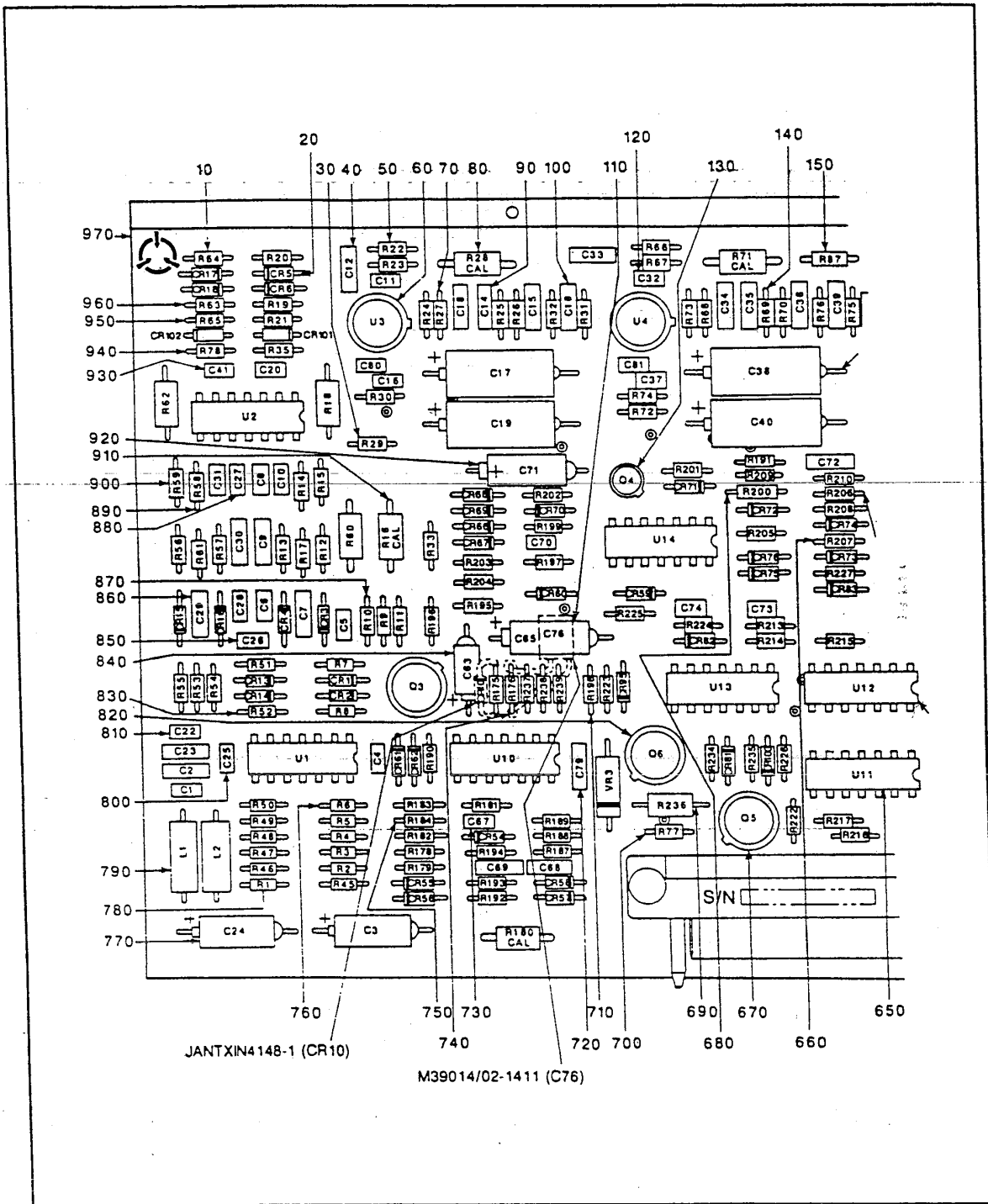

Modification of Wheel Control Board to 6004384-2/5R90-829  
Figure 1 (Sheet 1 of 2)

Aug 1/92  
Revision No. 1  
Jun 29/94

Fo50-32-4  
Page 3 of 6

**AIRCRAFT BRAKING SYSTEMS**  
Corporation

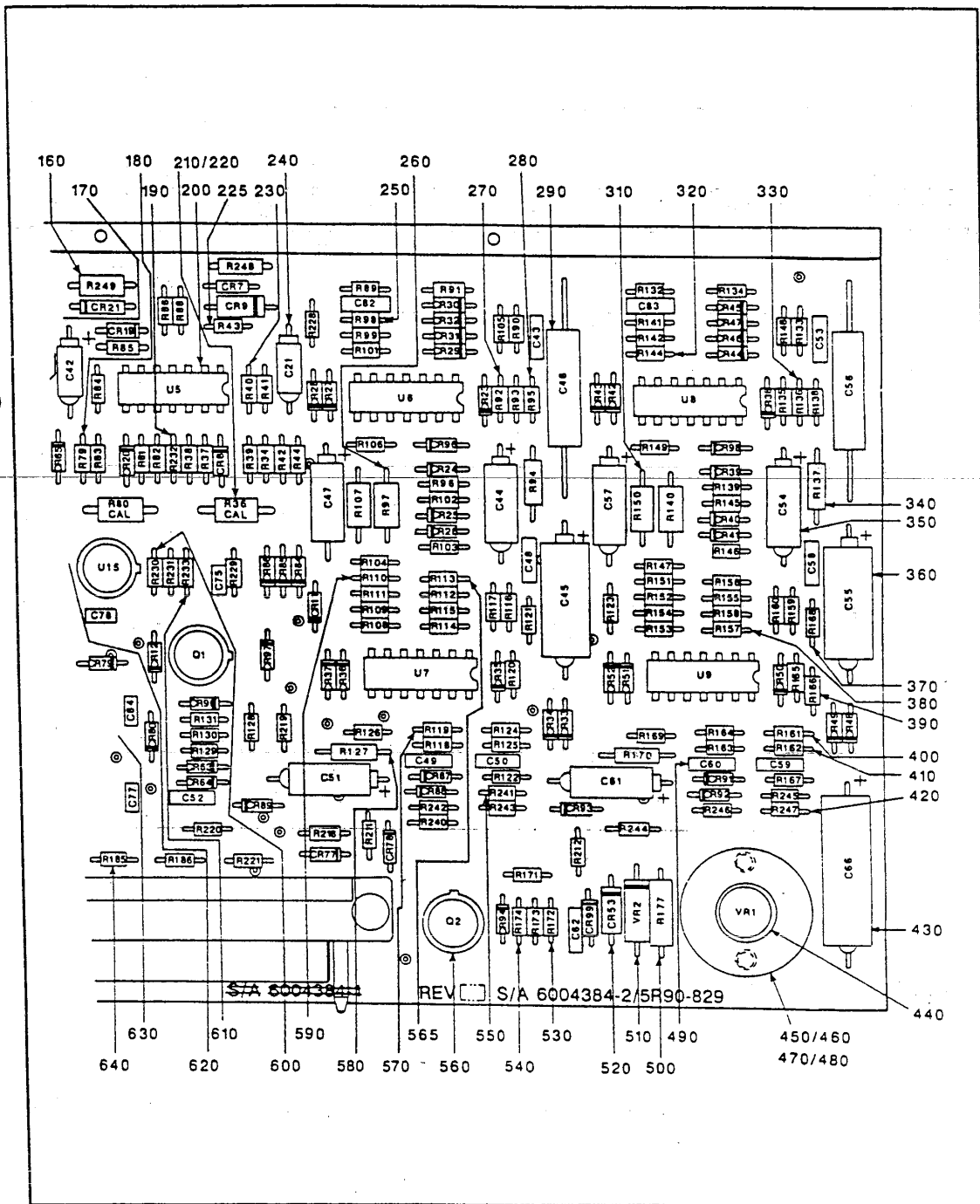

Modification of Wheel Control Board to 6004384-2/5R90-829  
Figure 1 (Sheet 2 of 2)

Aug 1/92  
Revision No. 1  
Jun 29/94

Fo50-32-4  
Page 4 of 6



---

**AIRCRAFT BRAKING SYSTEMS**  
Corporation

**WARNING:** USE POLYURETHANE COATING ONLY IN A WELL-VENTILATED AREA. DO NOT INHALE FUMES AND AVOID PHYSICAL CONTACT WITH THE COATING.

- 4 Apply a protective coating of Hysol PC-29M or Humiseal 1B31 over each component and the repaired area of the board. Apply only a very thin coat, 0.002 inch (0,051 mm) maximum and do not allow a buildup of coating between the other parts of the board.

C. Reidentification of Control Boards

- (1) Board identification is located adjacent to the board connector as shown in Figure 1.
- (2) On each control board, cross out but do not obliterate existing identification.
- (3) Reidentify board as part number S/A 6004384-2/5R90-829 in 0.10 inch (2,54 mm) high characters, using a contrasting color epoxy marking ink, Hysol Wornowink, Series M.

D. Reidentification of Control Unit Assembly 6004125 to 6004125-1

- (1) Remove existing Identification Plate 6004357 from control unit and discard.
- (2) Using a new Identification Plate 6004357, metal stamp existing control unit serial number on designated pad and "-1" after part number 6004125 in 0.06 inch (1,52 mm) high characters.
- (3) Install new Identification Plate 6004357 on the control unit.

E. Control Unit Reassembly

- (1) Install each "S/A 6004384-2/5R90-829" Wheel Control Board Subassembly in appropriate card slot.
- (2) Slide chassis subassembly into the cover using retained screw. Secure turnlock fastener at rear of control unit.

F. Acceptance Testing of Control Unit Assembly 6004125-1

- (1) Perform full control unit assembly test in accordance with TESTING AND FAULT ISOLATION section of referenced Component Maintenance Manual, paragraph 3.

G. On-Board Aircraft BITE Test of Control Unit

- (1) An aircraft checkout (BITE test) of the control unit should also be performed with Auto-Brake powered down.

Aug 1/92

Fo50-32-4  
Page 5 of 6

**AIRCRAFT BRAKING SYSTEMS**  
Corporation

SECTION III - MATERIAL INFORMATION

A. The following parts are required to rework each brake assembly.

New Part Number	Units Per Assembly	Nomenclature	Old Part Number	Disposition
M39014/02-1411	1	CAPACITOR	-	-
JANTXIN4148-1	1	DIODE	-	-
6004357	1	PLATE, Identification . . . . .	6004357	Discard

B. The following bulk material shall be required.

Bulk Material - As Required	Recommended Source
Cleaning Solvent TP-35 Freon	E.I. DuPont DeNemours & Company, Incorporated Petrochemicals Department Freon Products Division 1007 Market Street Wilmington, DE 19898
Insulation Tubing B7444-3-2-16B	Commercially available
Sealant 0151	Hysol Division The Dexter Corporation 211 Franklin Street Olean, NY 14760
Sealant, Polyurethane Coating Type PC-29M	Hysol Division The Dexter Corporation 1505 East Don Julian Road P.O. Box 1282 Industry, CA 91749-1282
Humiseal Electronic Component Protective Coating IB31	Columbia Chase Corporation Humiseal Division 26-60 Brooklyn-Queens Expressway West P.O. Box 445 Woodside, NY 11377-0445
Trichloroethane Specification MIL-T-81533	Commercially available
Stiff-Bristled Fiberglass Brush	Commercially available
Epoxy Marking Ink Hysol Wornowink Series M Specification MIL-I-43553	Hysol Division The Dexter Corporation 1505 East Don Julian Road P.O. Box 1282 Industry, CA 91749-1282

Aug 1/92  
Revision No. 1  
Jun 29/94

Fo50-32-4  
Page 6 of 6

## **APPENDIX 6**



**Fokker 50**  
SERVICE LETTER

ATA ch. 76

137

ENGINE CONTROLS

Automatic Flight Idle Stop - Operation of the Flight-Idle Stop Solenoids during Flight.

Effectivity: All F27 Mark 050 and 0502 aircraft.

Introduction

A primary (mandatory) mechanical stop is installed in the flight compartment to prevent inadvertent movement of the power levers into the Ground (or Beta) range during flight. In addition to this, a secondary (back-up) stop is installed on each engine, this is the automatic flight-idle stop.

This Service Letter informs the operators about two issues related to the operation of the automatic flight-idle stop; Firstly the possibility that pilots may lift the ground-range selector-levers and move the power levers through the primary stop during flight. Secondly, the possibility of inadvertent operation during flight of the secondary or so called automatic flight-idle stop.

Background information/Recommendations

Primary stop (Refer to figure 1)

It has been reported that handling of the ground-range selector-levers occurs during flight, e.g. when the hand of the pilot holds the selector levers during turbulent weather conditions. This may result in the situation that the power levers pass the primary stop and now rest against the secondary stop. When the engine controls are incorrectly adjusted this may result in a propeller RPM/drag increase. When the power levers remain against the secondary stop during aircraft landing, it may not be possible to move the power levers into the Ground range due to the imposed friction.

AFM procedures recommend operation of the selector levers only after nose wheel touch-down. For this issue it is considered the operators responsibility to take action where considered appropriate.

Page	1	2	3	4															
Revision	-	-	-	-															

Dec 20/94

Fokker 50  
Service Letter 137  
Page 1



## Fokker 50

### SERVICE LETTER

#### Secondary stop (Refer to figure 1 and 2)

The secondary or so called automatic flight-idle stop prevents inadvertent entering of the propeller into the Ground range during flight if the ground-range selector-levers are accidentally operated. The location of this secondary stop on the engine also ensures protection after a control cable failure.

When the flight-idle stop solenoids (one on each engine) are energized, the lock-lever is withdrawn from the power levers. This makes it possible to retard the power levers into the Ground range after landing of the aircraft. During normal operation of the system, the solenoids will be energized after landing when one of the following input signals is available:

- Wheel speed-up signal (20 MPH) from the anti-skid control system
- Ground signal from the Ground/Flight relays.

However in-service experience revealed that the flight-idle stop solenoids may also be energized, during flight, for a period of 16 seconds under the following circumstances:

1. When both the LH and RH main landing gear uplock-switches are de-energized at the exactly the same time. Although considered to be remote, this may happen during each flight when the landing gear is selected down.  
The occurrence of this phenomenon can be prevented with a skid control unit modification. This modification, when incorporated, changes the partnumber of the skid control unit from 6004125 into 6004125-1 and is covered by Service Bulletin Fo50-32-4 from the vendor Aircraft Braking Systems. This modification was incorporated into anti-skid unit s/n AUG92-117 and subsequent.
2. During an operational check of the anti-skid system. The AOM recommends to perform this check before the landing when a lightning strike is experienced while the landing gear is down. Besides activation of the automatic flight-idle stop, also the rating on the ERP may change automatically to Go Around when the "Cruise rating in approach" modification is incorporated (refer to SBF50-73-010) into the aircraft. Fokker considers to include a note in the AOM which informs flight crews about this possible rating change.
3. When, during flight, the TOW switch is operated from NORMAL to TOW and back to NORMAL. There is no procedure recommended in the AOM to cycle the TOW switch during flight.



**Fokker 50**  
SERVICE LETTER

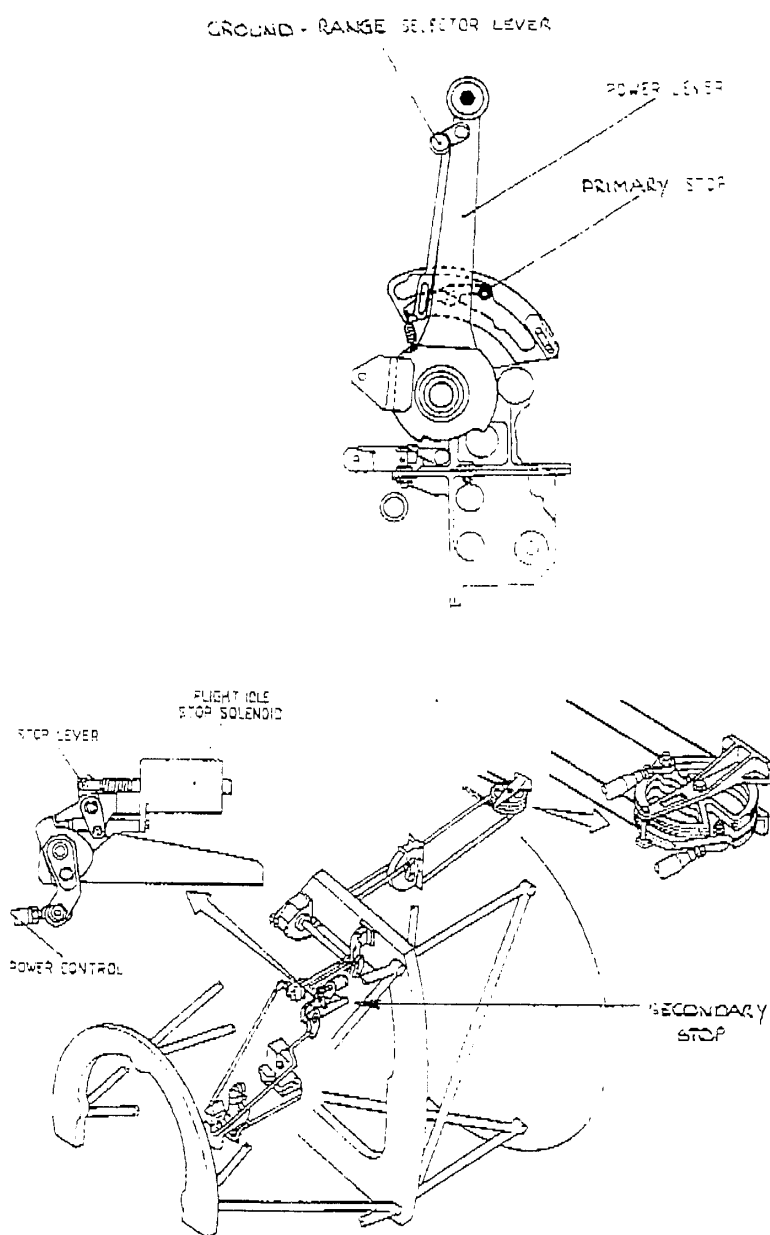

The Automatic Flight Idle Stop  
Figure 1

Dec 20/94

Fokker 50  
Service Letter 137  
Page 3



**Fokker 50**  
SERVICE LETTER

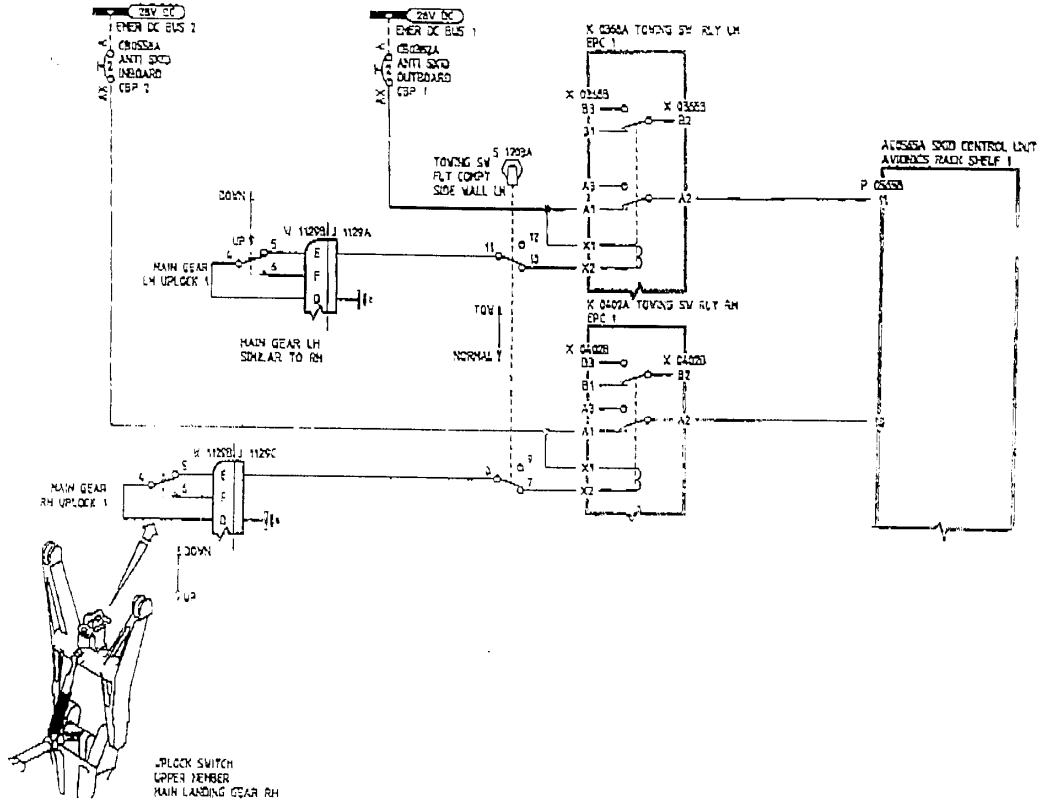

The Anti-Skid Control System  
Figure 2

Fokker 50  
Service Letter 137  
Page 4

Dec 20/94

## **APPENDIX 7**



## LANDING GEAR

Wheels and brakes – Introduction of new ground connections for the Anti-Skid box.

### 1. Planning Information

#### A. Effectivity

- (1) F27 Mark 050, 0502 and 0604 aircraft serial numbers:  
20103 thru 20335.
- (2) Production version: Not applicable.

#### B. Reason

- (1) Cases have been experienced of intermittent or no braking action from the normal braking system.  
Investigation has learned that this is caused by EMI disturbance signals. The EMI signals cause undesired signals in the wiring from the wheel speed sensors to the anti skid control box, which in turn could cause undesired dump-signals from the anti-skid control box. As a result of this hydraulic brake pressure will be dumped resulting in intermittent or no braking action.

This Service Bulletin is issued to inform the operators how to change the "ground" wiring to the anti skid control box.

#### C. Description

- (1) This Service Bulletin tells you how to:
  - Remove the avionics shelf that holds the Anti-skid box.
  - Do rework on ground connections.
  - Install the shelf in the avionics rack.
  - Do the test procedures.

Page	1	2	3	4	5	6	7	8	9	10	11	12	13	14	15	16	17
Revision	-	-	-	-	-	-	-	-	-	-	-	-	-	-	-	-	-

Aug 02/99

SBF50-32-035

Page 1



## D. Compliance

- (1) Recommended.

## E. Approval

- (1) The technical information contained in this Service Bulletin has been approved under the authority of the JAA Design Organization Approval no. RLD.JA.001.

## F. Manpower

- (1) Approximately 8 man-hours are necessary to do this Service Bulletin on 1 aircraft.

This table of manpower will help you to schedule and do this Service Bulletin:

Instructions	Men	Man-hours	Elapsed time (hours)
Inspection	-	-	-
Removal	1	1.5	1.5
Modification	1	3	3
Installation	1	3	3
Testing	2	3	1.5
Total		8	6

- (2) The estimated hours are for direct labor done by experienced personnel. They are calculated based on the conditions given in the Service Bulletin Introduction, section 2.C., "Manpower".

## G. Material - Cost and Availability

- (1) You can order the necessary parts as mod kit SBF50-32-035A, SBF50-32-035B or SBF50-32-035C.

## H. Tooling - Price and Availability

- (1) Not applicable.

## J. Weight and Balance

- (1) Weight change: none
- 
- Index change: none.

## K. Electrical Load Data

- (1) Not affected.

## **APPENDIX 8**

**AIRWORTHINESS DIRECTIVE**

AD : LUX-2002-001

Grand-Duché de Luxembourg  
Ministère des Transports  
Direction de l'Aviation Civile  
(DAC)

**Applicability :** Fokker F.27 Mk.050 and 0502 series airplanes; certificated in any category.

**Note 1 :** This AD applies to each airplane identified in the preceding applicability provision, regardless of whether it has been modified, altered, or repaired in the area subject to the requirements of this AD.

**Compliance :** Required as indicated, unless accomplished previously.  
To prevent the selection of a lower pitch than the low pitch for flight.

**Corrective actions :**

1.
  - LANDING GEAR SKID CONTROL SYSTEM – Control unit rework instructions in accordance with Fokker 50 Aircraft Braking Systems Service Bulletin Fo50-32-4 revision 1 dated 29/06/1994.
  - WHEELS AND BRAKES – Introduction of new ground connections for the Anti-Skid Box in accordance with Fokker 50 Service Bulletin F50-32-035.
  - ENGINE CONTROLS – Automatic Flight Idle Stop – Operation of the Flight-Idle Stop Solenoids during Flight in accordance with Fokker 50 Service Letter N°137/1994

2.
 

All responsible aircraft pilots have to be explicitly and expressly informed that there are certain conditions where the solenoids can be inadvertently activated in flight. The reference to the corresponding chapters in the Airplane Flight Manual (AFM) has to be noticed to the pilots.

**Effective Dates**

Corrective action 1 of this amendment becomes effective on January 1<sup>st</sup>, 2003.

Corrective action 2 of this amendment becomes effective on November 29, 2002.

Issued in Luxembourg, on November 29, 2002.

Airworthiness office, Direction of Civil Aviation

## **APPENDIX 9**



## Fokker 50/60 All Operators Message

Dated : May 08, 2003

Sequence No. : **AOF50.028**  
Ref. No. : TS03.52599  
Page : 2 OF 3

**Subject: Fokker 50 – Skid control unit modification, up-date #1.**

This All Operators Message is to inform you that Service Bulletin SBF50-32-038 has been issued as a cover Service Bulletin for the ABSC SB 6004125-32-01 introducing a new modification of the Skid Control Unit to improve EMI protection and to suppress the 20 mph wheelspeed discretes during Skid Control Unit test (while retaining a previous modification), as already announced in AOF50.024.

Note: In the previous AOF the new ABSC SB was announced as SB Fo50-32-07, however, due to a new numbering system at ABSC, the subject SB got a new number:

**ABSC SB 6004125-32-01**

In AOF50.024 the background of the previous modification to the Skid Control Unit as well as the reason for the new modification were extensively explained.

The AOF ended with the expectation that the SB's introducing this new modification would be issued at the end of February 2003.

However, at a very late stage a shortcoming in the modification was discovered. The correction of this shortcoming caused a delay in issuing both SB's.

**Fokker Services SBF50-32-038:**

Fokker Service Bulletin SBF50-32-038 has been issued as a Fokker Services cover Service Bulletin requiring the accomplishment of a number of Service Bulletins to improve the Skid Control Unit.

This Service Bulletin requires the accomplishment of:

- ABSC SB 6004125-32-01
- Fokker Services SBF50-32-035

It is expected that this SB will be mandated by the CAA-NL with a compliance time of 1 year after the issue date of this SB for pre ABSC SB Fo50-32-4 units (identified as 6004125) and 1,5 year for post ABSC SB Fo50-32-4 units (identified as 6004125-1).

**ABSC SB 6004125-32-01:**

ABSC SB 6004125-32-01 has been issued to modify the Skid Control Unit electronic circuits in order to reduce the EMI susceptibility of the wheelspeed sensor input and test inputs of the Skid Control Unit. The SB also includes the modification introduced with ABSC SB Fo50-32-04 for those units which are still pre that SB.

Accomplishment of this Service Bulletin on the Skid Control Units p/n 6004125 and 6004125-1 will modify these Units into a Skid Control Unit p/n 6004125-2.

Sequence No. : **AOF50.028**  
Ref : TS03.52599

Page 2 of 3

Fokker Services

---

**Fokker Services SBF50-32-035:**

Fokker Service SBF50-32-035 is an existing SB, which was already issued in Aug 1999. This SB introduces a modification of the aircraft wiring to reduce the levels of EMI on the wheelspeed sensor wiring by relocating the Skid Control Unit Signal grounds from the aircraft structure to the avionics shelf.

**In conclusion:**

With these modifications incorporated, abnormal braking, loss of braking at low speeds as well as unintended energizing of the flight idle stop solenoids are considered to be adequately covered.

Copies of the subject Service Bulletins are attached and also available at the Fokker Services web-site <https://www.myfokkerfleet.com> (restricted site for customers only) as an attachment to this All Operator Message.

Sincerely yours,

F.T. van de Pol  
Vice President Technical Services  
Fokker Services bv

Sequence No. : **AOF50.028**  
Ref : TS03.52599

Page 3 of 3

## **APPENDIX 10**





Copyright All rights reserved by Fokker Services B.V. (The Netherlands). This document has been supplied by Fokker Services B.V. to its customers on a confidential basis subject to the provisions of an agreement. Reproduction or disclosure to third parties of this document or any part thereof, or the use of any information contained therein for purposes other than explicitly allowed by the aforesaid agreement, is not permitted except with the prior written permission of Fokker Services B.V.

## LANDING GEAR

Wheels and Brakes - The Modification of the Skid Control Unit.

### 1. Planning Information

#### A. Effectivity

- (1) F27 Mark 050, 0502 and 0604 aircraft serial numbers:  
20103 thru 20335.
- (2) Production version of this modification: Not applicable.

#### B. Reason

- (1) The Skid Control Unit has been modified to provide a solution for reported pulsating brake behavior and loss of braking at low speeds in the normal braking mode. Investigation of this behavior has shown that EMI, caused by failed components in other electronic systems and induced on the wheel speed sensor and/or test inputs of the Skid Control Unit was the cause of these problems. The modifications that are introduced provide a significant reduction of its EMI susceptibility.

The modified Skid Control Unit also provides suppression of the 20 mph wheel-speed discrettes during the execution of a Skid Control System test in flight, which is recommended by the AOM to be performed after a lightning strike with landing gear down. This suppression was considered necessary because the 20 mph wheel-speed discrettes activate the Ground Control Relay and Flight-Idle-Stop solenoid (for 16 sec) of the propeller control system. After modification inadvertent effects on the propeller control are eliminated.

Page	1	2	3	4													
Revision	-	-	-	-													

May 08/03

SBF50-32-038  
Page 1



## Service Bulletin Fokker 50/60

Copyright All rights reserved by Fokker Services B.V. (The Netherlands). This document has been supplied by Fokker Services B.V. to its customers on a confidential basis subject to the provisions of an agreement. Reproduction or disclosure to third parties of this document or any part thereof, or the use of any information contained therein for purposes other than explicitly allowed by the aforesaid agreement, is not permitted except with the prior written permission of Fokker Services B.V.

- (2) Aircraft Braking Systems Corporation has issued Service Bulletin 6004125-32-01 to introduce Skid Control Unit 6004125-2 with the modifications mentioned under paragraph (1) implemented.

NOTE: This new part number also includes the modifications that were introduced in Skid Control Unit with part number 6004125-1 to prevent inadvertent generation of 20 mph wheel-speed discretes during power-up at landing gear extension.

- (3) To reduce the level of EMI that may be induced on the wheel-speed sensor wiring, the ground connections of the skid control unit must also be adapted, refer to Fokker Services SBF50-32-035.

### C. Description

- (1) This Service Bulletin tells you how to:
- Remove skid control unit pn 6004125 (all mods) or pn 6004125-1
  - Install skid control unit pn 6004125-2.
- (2) Before, or and the same time as, you do this SB, you must do:
- SBF50-32-035 - LANDING GEAR - Introduction of new Connections for the Skid Control Unit.

### D. Compliance

- (1) Fokker Services recommends the accomplishment of this Service Bulletin within 12 months after the date of issue of this Service Bulletin if the Skid Control Unit is in a PRE ABSc Service Bulletin F50-32-4 configuration.
- (2) Fokker Services recommends the accomplishment of this Service Bulletin within 18 months after the date of issue of this Service Bulletin if the Skid Control Unit is in a POST ABSc Service Bulletin F50-32-4 configuration.

NOTE: It is expected that the CAA-NL will set the same compliance terms in the Dutch Airworthiness Directive (BLA) that will be issued with respect to this subject.

### E. Approval

- (1) The technical information contained in this Service Bulletin has been approved under the authority of JAA Design Organization Approval no. RLD.JA.001.

### F. Manpower

- (1) The normal time for removal/installation of the anti-skid control unit.
- (2) For the modification to the Skid Control Unit, refer to Aircraft Braking Systems Service Bulletin 6004125-32-01.

### G. Material - Cost and Availability

- (1) Refer to the Aircraft Braking Systems Service Bulletin 6004125-32-01.



Copyright All rights reserved by Fokker Services B.V. (The Netherlands). This document has been supplied by Fokker Services B.V. to its customers on a confidential basis subject to the provisions of an agreement. Reproduction or disclosure to third parties of this document or any part thereof, or the use of any information contained therein for purposes other than explicitly allowed by the aforesaid agreement, is not permitted except with the prior written permission of Fokker Services B.V.

#### H. Tooling - Price and Availability

- (1) Not applicable.

#### I. Weight and Balance

- (1) Weight change: None  
 Index change: None.

#### J. Electrical Load Data

- (1) Not affected.

#### K. References

- (1) Fokker 50/60 Aircraft Maintenance Manual (AMM)  
 Fokker 50/60 Service Bulletin (SB):  
 - SBF50-32-035  
 Aircraft Braking Systems SB:  
 - F50-32-4  
 - 6004125-32-01  
 Fokker internal reference(s):  
 - ECR 52588.

#### L. Publications Affected

- (1) This SB affects the publications listed below:

(a) Maintenance Documentation

- |  |                  |
|--|------------------|
| - Fokker 50/60 Wiring Manual (WM)              | - chapter 32-45  |
| - Fokker 50/60 Illustrated Parts Catalog (IPC) | - chapter 32-45. |

NOTE: See attached Manual Change Notification MCNM F50-045.

(b) Maintenance Programs

Not affected.

(c) Operational Documentation

Not affected.

- (2) For incorporation of this Service Bulletin in your documentation refer to the Service Bulletin Introduction, section 4 "Incorporation of Service Bulletins in Documentation of Fokker Services".

May 08/03

SBF50-32-038  
 Page 3



## **APPENDIX 11**

**AIRCRAFT BRAKING SYSTEMS**  
Corporation

# SERVICE BULLETIN

**Subject:** LANDING GEAR - SKID CONTROL SYSTEM

INTRODUCTION OF SKID CONTROL UNIT ASSEMBLY 6004125-2

## SECTION I - PLANNING INFORMATION

1. **EFFECTIVITY:** This Service Bulletin is applicable to Skid Control Unit Assemblies 6004125 and 6004125-1 used on the F27 MK050 (Fokker 50) Aircraft.
2. **CONCURRENT REQUIREMENTS:** Incorporation of Service Bulletin Fo50-32-4, Revision 1, dated 29 June 1994, to modify 6004125 Skid Control Unit to 6004125-1 Skid Control Unit.
3. **REASON:** This Service Bulletin is issued to inform operators of the new Skid Control Unit 6004125-2. It provides instructions to return existing control units to Aircraft Braking Systems Europe Limited (ABSEL) for modification of the 6004125 and the 6004125-1 control unit assembly into Skid Control Unit 6004125-2.

ABSC has received reports of degraded braking caused by too much antiskid activity. The cause is electromagnetic interference (EMI) from other avionics systems. EMI is conducted into the skid control unit through the aircraft wiring. This may cause incorrect antiskid activity, resulting in degraded braking. While the skid control unit is designed to reject a limited amount of EMI, aging effects on some aircraft have increased EMI radiation to the extent that normal antiskid operation can be affected.

In addition to the EMI hardening of Skid Control Units 6004125 and 6004125-1, the unit will be modified to disable the Wheel Speed Discrete circuit relays during manual application of the "Built-In-Test (BIT)" push button. "BIT" can be applied from the front panel test button or remotely from the cockpit if a Skid Control Unit is installed on the aircraft.

4. **DESCRIPTION:** This Service Bulletin notifies operators of the availability of the new Skid Control Unit 6004125-2 for use on the Fokker 50 aircraft.

One difference between Skid Control Unit Assemblies 6004125-1 and 6004125-2 is a hardware change to the wheel speed and built-in-test (BIT) circuits on the two (2) Control Board Subassemblies 6004384-2. The modified control board subassemblies will have the new part number 6004384-3.

A second difference is that the Auxiliary Printed Wiring Board (AUX Board) is also modified to disable the relays that control the Wheel Speed Discrete Circuit during manual application of the "Built-In-Test (BIT)". Additional hardware components from the BIT initiate switch will disable the discrete circuit when the BIT test switch is closed.

Inclusion of additional hardware will harden the noted modifications to EMI. Pins are added to the AUX Board connectors in the Control Unit Chassis. Two wires are added to the chassis wire harness to connect the new AUX Board connector pins to the BIT switch on the front panel of the chassis. The AUX Board will have the new part number 6004386-2.

May 07/03

(RELEASED: 05/07/03 )  
© ABSC 2003 ALL RIGHTS RESERVED

Fo50  
6004125-32-01

Page 1 of 3

---

**AIRCRAFT BRAKING SYSTEMS**  
Corporation

5. COMPLIANCE: Refer to Fokker Services SBF50-32-038 for compliance instructions. This SB can be accomplished by returning the units to ABSEL to incorporate the necessary changes. To schedule the return of your units, please contact Customer Support after 14 March 2003 at the following address:

Aircraft Braking Systems Europe Limited  
683-685 Stirling Road  
Slough, Berkshire, England SL1 4ST  
Phone: 44-1-753-696-006  
Fax: 44-1-753-696-012  
Telex: 846695-ABSEL-G  
Sita: LHRLLCR  
Reference ABSC Service Bulletin 6004125-32-01

6. APPROVAL: Compliance with this Service Bulletin does not alter FAA Parts Manufacture Approval (PMA) conformance. Fokker Services has approved this Service Bulletin.
7. MANPOWER: None.
8. WEIGHT AND BALANCE: No Effect.
9. ELECTRICAL LOAD DATA: No Effect.
10. SOFTWARE ACCOMPLISHMENT SUMMARY: Does not apply.
11. REFERENCE(S):
- A. AP-647 (32-47-52) Component Maintenance Manual for Skid Control Unit Assembly Part Numbers 6004125 and 6004125-1 (basic issue dated 14 February 1986), Revision No. 5 dated 28 June 1995.
- B. Fokker 50 Service Bulletin Fo50-32-4, Revision 1, dated 29 June 1994.
12. OTHER PUBLICATIONS AFFECTED: Does not apply.
13. INTERCHANGEABILITY AND INTERMIXABILITY: Does not apply.

SECTION II - MATERIAL INFORMATION

1. MATERIAL - Price and Availability: The cost to modify to Skid Control Unit Assembly 6004125-2 is \$3,750.00 each for units modified through 31 December 2003. See COMPLIANCE on this page for returning antiskid control units.

May 07/03

Fo50  
6004125-32-01  
Page 2 of 3

---

**AIRCRAFT BRAKING SYSTEMS**  
Corporation2. MATERIAL - Necessary Materials:

A. The parts necessary to do the changes given in this Service Bulletin are as follows:

New Part Number	Nomenclature	Old Part Number	Quantity	Disposition
6004125-2	SKID CONTROL UNIT ASSEMBLY	6004125 or 6004125-1	1	Return to manufacturer for modification

3. TOOLING - Price and Availability: Does not apply.**SECTION III - ACCOMPLISHMENT INSTRUCTIONS**

A. The modifications specified by this Service Bulletin cannot not be done by the operators. Return all skid control units to Aircraft Braking Systems Corporation for modification as told in COMPLIANCE in SECTION I - PLANNING INFORMATION.

May 07/03

Fo50  
6004125-32-01  
Page 3 of 3



## **APPENDIX 12**

**MCNM-F50-045**

- Subject : The Modification of the Skid Control Unit .
- Reason : This MCN is issued to provide you with the changes on the content(s) of the affected manual(s), due to the introduction of SBF50-32-038.
- Effectivity : F27 Mark 50 , 0502 and 0604 aircraft serial numbers: 20103 thru 20335.
- Compliance : Once you have determined the applicability of this MCN for one or more of your aircraft, incorporate this information into the applicable manual(s).
- Publications : The Illustrated Parts Catalog (IPC)  
Affected : The Wiring Manual (WM)
- Change Note : **IPC**  
**Chapter 32-45-00 Fig. 01 ANTI-SKID SYSTEM**  
To be updated to show the new part number 6004125-2 of the modified Skid Control Unit (Refer to ABS SB6004125-32-01).
- Change Note : **WM**  
**Part 1, Equipment List, series PL**  
To be updated to show the new part number 6004125-2 of the modified Skid Control Unit (Refer to ABS SB6004125-32-01).

NOTE : If you have a Documentation Revision Service (DRS) with Fokker Services, this information will be included into your manuals at the earliest opportunity.

May 08/03

MCNM F50-045  
Page 1 of 1

## **APPENDIX 13**

**AIRWORTHINESS DIRECTIVE****AD : LUX-2003-001**

Grand-Duché de Luxembourg  
Ministère des Transports  
Direction de l'Aviation Civile  
(DAC)



**Applicability** : Fokker F.27 Mk.050 and 0502 series airplanes; certificated in any category.

**Note 1** : This AD applies to each airplane identified in the preceding applicability provision, regardless of whether it has been modified, altered, or repaired in the area subject to the requirements of this AD.

**Compliance** : Required as indicated, unless accomplished previously.

**Corrective action**

-LANDING GEAR - SKID CONTROL SYSTEM – Control unit rework instructions in accordance with Aircraft Braking Systems Corp. Fokker 50 Service Bulletin ABSC SB 6004125-32-01 dated 07/05/2003.

-WHEELS AND BRAKES – THE MODIFICATION OF THE SKID CONTROL UNIT – Skid Control Unit modification to reduce the EMI susceptibility of the windspeed sensor input and test inputs of the Skid Control Unit and suppression of the 20 mph wheelspeed discretes in accordance with Fokker 50 Service Bulletin SBF50-32-038 dated 08/05/2003.

**Reference**

-Fokker All Operators Message AOF50.028 - Fokker 50 – Skid Control Unit modification, up-date #1 dated 08/05/2003.

-Fokker Manual Change Notification MCNM F50-045 – New part number 6004125-2 of the modified Skid Control Unit dated 08/05/2003.

**Effective Dates**

This amendment becomes effective on November 1<sup>st</sup>, 2003.

Issued in Luxembourg, on May 12, 2003.

Airworthiness office, Civil Aviation Authority.

## **Appendix 14**

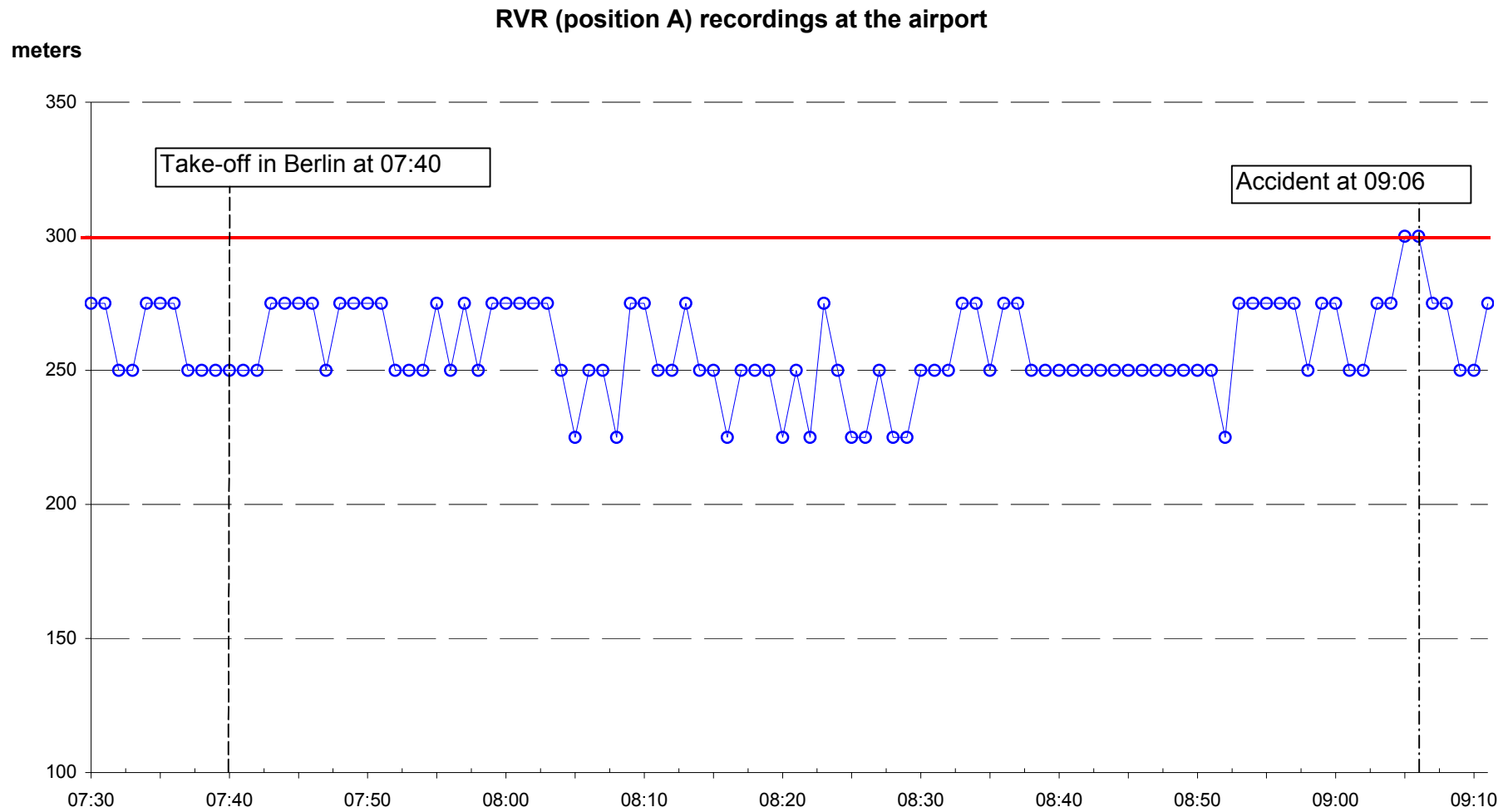

## **APPENDIX 15**

## F50 - NORMAL PROCEDURES

A.O.M. F 2.3

sheet 25

**2.3.20 LOW VISIBILITY OPERATIONS****100 GENERAL**

Special aircraft and ground equipment are required as well as specific crew qualification.

Training for low visibility take-off and Cat II approaches will be performed in accordance with the Operations Manual Part D. Crew qualifications required and basic procedures are detailed in the Operations Manual Part A, General Basics, chapter 5 and chapter 8.4 respectively.

The approach briefing is performed by the PF. However, before any low visibility approach, the Commander shall perform an operational review of the procedures, callouts and aircraft handling in case of missed approach.

Because the barometric altimeter is not used for the determination of the landing minimum, there is no requirement to perform an altimeter check for Cat II approaches. The outer marker check must however be made.

Below 500 ft, the radio altimeter becomes the primary instrument to measure the height of the aircraft in relation to the ground.

Early detection of pilot incapacitation during low visibility approaches is utmost important.

**The pressure altimeter bug shall be set to 500 ft above TDZ elevation rounded up to the nearest 20 ft.**

The periodic practice of real or simulated low visibility approaches is a requirement.

NOTE: Due to the steep rising terrain in Luxembourg RWY 24, the barometric altimeter has to be used down to an altitude of 300 ft AAL. The altimeter bug will nevertheless be set to 1720 ft, **but** the "+200 – no flag" call shall be made passing 1520 ft on the barometric altimeter. Only now the radio altimeter becomes the primary altitude readout instrument.

**200 OPERATIONAL REVIEW**

To conduct actual Cat II approaches, both pilots must be qualified.

Prior to starting the approach (preferably before top of descent), check the Notams, airport status and Company minima.

Check the aircraft maintenance status.

For Cat II, the wind limits are:

- Total wind: 20 kts
- Crosswind component: 15 kts
- Tailwind component: 10 kts
- No gust, no shear

**300 TASK DISTRIBUTION FOR CAT II APPROACHES**

For Cat II (or monitored approaches in general), the F/O flies the aircraft through the A/P and the Commander lands the aircraft, if sufficient visual references are available at minima.



Rev 2: 15 Nov 00



A.O.M. F 2.3

## F50 - NORMAL PROCEDURES

sheet 26

## 400 CALLOUTS DURING A CAT II APPROACH

The basic operational callouts described above for Cat 1 ILS approaches remain valid for Cat II, with the following exceptions:

- No altimeter check
- Additional callout performed at 500 feet above TDZ.

The F/O is acting as PF during approach till minimum, where the Commander takes over control of the aircraft if visual references are sufficient.

PF (F/O)	PNF
	Ann.: « <b>LOC ALIVE</b> »
Ann.: « <b>CHECKED</b> »	
At Loc capture, ann.: « <b>LOCALIZER CAPTURE, SET MISSED APP. HEADING</b> »	Sets and ann.: « <b>CHECKED - MISSED APP. HEADING SET</b> »
	Ann.: « <b>GLIDE ALIVE</b> »
Ann.: « <b>CHECKED</b> »	
At glide capture, ann.: « <b>GLIDE CAPTURE, SET MISSED APP. ALTITUDE</b> »	Sets and ann.: « <b>CHECKED - MISSED APP. ALTITUDE SET</b> »
Passing the OM or equivalent, ann.: « <b>OUTER MARKER, (VALUE READ) FEET</b> »	If satisfied, ann.: « <b>CHECKED</b> »
When passing 500 ft AAL call: « <b>500 FEET</b> »	Call: « <b>CHECKED</b> »
200 ft above DA, call out: « <b>+ 200, NO FLAGS</b> »	Confirms, ann.: « <b>CHECKED</b> »
100 ft above DA: « <b>APPROACHING MINIMUM</b> »	Call out: « <b>CHECKED</b> »
At DA, call out: « <b>MINIMUM</b> »	
If the required visual references have been established, the Commander takes over control of the aircraft and announces: « <b>LANDING</b> ».	
The F/O answers « <b>MONITORING</b> », keeps "head down", monitors the flight path on instruments and calls out any deviations. At 50 ft RA, callout « <b>50 FEET</b> ».	
The Commander disconnects the A/P and announces: « <b>DISCONNECTED</b> ».	
If no visual references at DH, the Commander calls out: « <b>GO AROUND</b> », the F/O answers « <b>GO-AROUND, FLAPS 10</b> » and performs the missed approach procedure.	



Rev 1: 10 May 00

## F50 - NORMAL PROCEDURES

A.O.M. F 2.3

sheet 27

## 500 CAT II ILS PROFILE

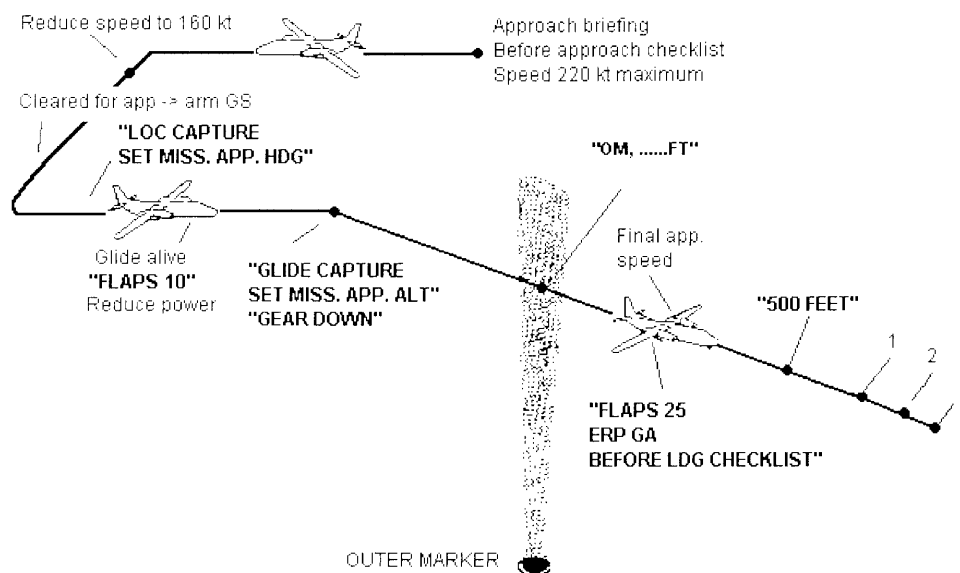

- 1: "+200, NO FLAG"  
 2: "APPROACHING MINIMUM"  
 3: "MINIMUM"  
 FOLLOWED BY EITHER: "LANDING or GO AROUND"



Rev 1: 10 May 00

## **APPENDIX 16**

## Excerpts from Original Tape Recording

### Approach radar control unit

#### Frequency 118.900

Points	Time in UTC	From	To	Communications
1	08:52:38	LGL9642	APP	Luxembourg Radar gudde Muergen Luxair nine six four two, descending flight level nine zero, uh, on course to..., Diekirch.
2	08:52:47	APP	LGL9642	Luxair niner six four two enter Diekirch holding at flight level niner zero it will be vectors later on for an I_L_S approach category two on two four. Q_N_H is one zero two tree current R_V_R beginning two five zero on mid section two seven five, stop end two two five.
3	08:53:05	LGL9642	APP	That's all understood, uh, Luxair nine seven, correction nine six four two.
4	08:54:44	LGL9642	APP	And Luxair nine six four two is reducing speed to one sixty.
5	08:54:47	APP	LGL9642	Roger nine six four two.
6	08:58:48	APP	LGL9642	Luxair niner six four two descend to tree thousand feet on one zero two tree turn left heading ...one tree zero.
7	08:58:57	LGL9642	APP	Descending tree thousand feet on Q_N_H, uh, one zero two tree and say again the heading?
8	08:59:04	APP	LGL9642	One tree zero.
9	08:59:07	LGL9642	APP	Uh, left heading one tree zero Luxair nine six four two.
10	09:01:21	APP	LGL9642	Luxair niner six four two turn right heading two two zero to intercept. Cleared for approach, report established on the localizer.
11	09:01:30	LGL9642	APP	Right heading two two zero and, uh, cleared approach and we call you established on the localizer nine six four two.
12	09:02:30	LGL9642	APP	Luxair nine six four two is now established on the localizer.
13	09:02:34	APP	LGL9642	Luxair niner six four two contact tower one one eight decimal one Äddi.
14	09.02.39	LGL9642	APP	Eighteen one nine six four two. Äddi

---

**Aerodrome control unit**
**Frequency 118.100**

Points	Time in UTC	From	To	Communications
15	09:02:48	LGL9642	TWR	Tuerm gudde Muergen Luxair nine six four two is, uh, established I_L_S two four
16	09:02:54	TWR	LGL9642	Luxair nine six four two gudde Muergen, continue approach the wind is calm R_V_R beginning two five zero meters mid section two five zero meters stop end two two five meters.
17	09:03:07	LGL9642	TWR	Uh, that's copied Luxair nine six four two, but we need tree hundred meters for the approach.
18	09:03:16	TWR	LGL9642	Nine six four two copied, uh, so continue approach I keep you advised. We didn't have tree hundred, uh, during the last, uh, time.
19	09:03:25	LGL9642	TWR	Uh, roger nine six four two we keep you advised. We're proceeding to Elu now and, uh, standing by, nine six four two.
20	09:03:35	TWR	LGL9642	Roger and we have, uh, zero degrees wind, uh.
21	09.03.40	TWR	LGL9642	Correction zero knots.
22	09:03:43	LGL9642	TWR	Roger.
23	09:04:59	TWR	LGL9642	Luxair nine six four two R_V_R tree hundred meters two seven five meters stop-end two seven five meters.
24	09:05:03	LGL9642	TWR	Nine six four two roger, so we continue.
25	09:05:07	TWR	LGL9642	Nine six four two you are cleared to land, wind one eight zero degrees five knots.
26	09:05:11	LGL9642	TWR	Cleared to land, uh, nine six four two

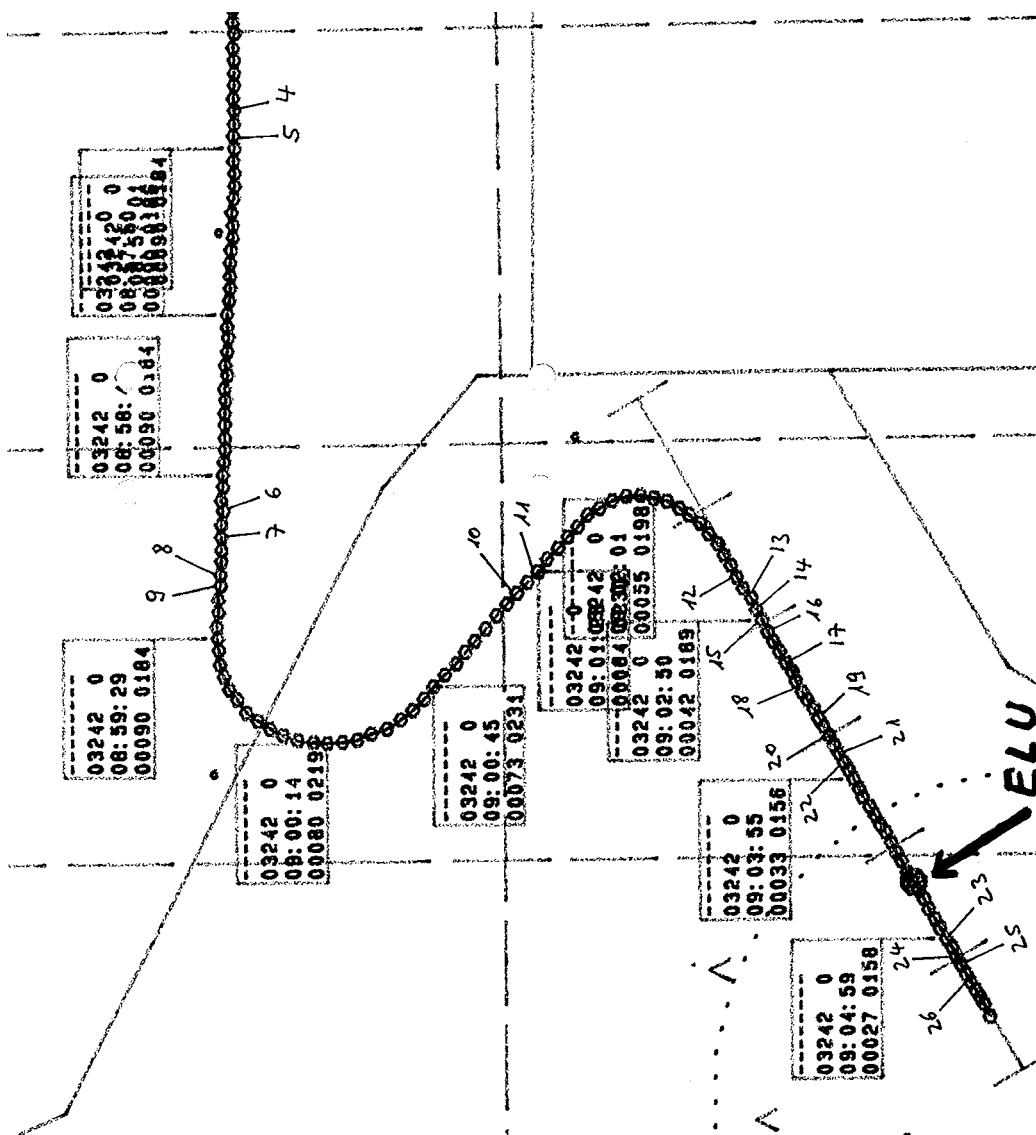

## **Appendix 17**

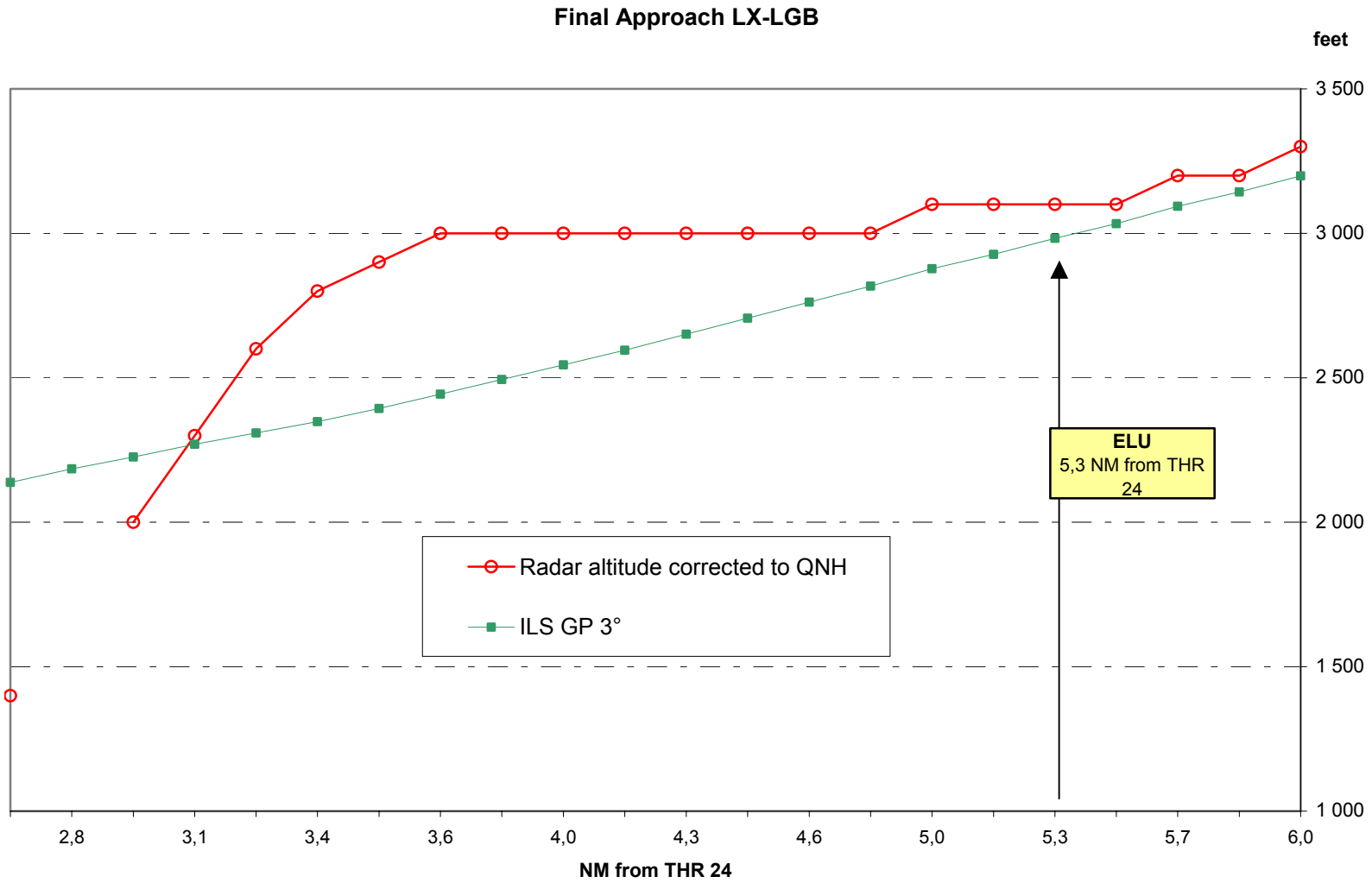



## **Appendix 18**



**Accident  
survenu le 6 novembre 2002  
en approche de l'aéroport  
de Luxembourg  
au Fokker 50  
immatriculé LX-LGB  
exploité par Luxair**

*Accident  
occurred on November 6, 2002,  
on approach to  
Luxembourg Airport  
to the Fokker 50  
registered LX-LGB  
operated by Luxair*

*RAPPORT D'EXPLOITATION DU CVR  
Essais complémentaires*

Cockpit Voice Recorder REPORT: Additional tests

**CVR - 2002 - BVD - 03**

---

<b>1</b>	<b>CIRCONSTANCES / CIRCUMSTANCES</b> .....	<b>151</b>
<b>2</b>	<b>ENREGISTREURS / RECORDERS</b> .....	<b>151</b>
<b>3</b>	<b>ESSAIS COMPLEMENTAIRES / ADDITIONAL TESTS</b> .....	<b>151</b>
3.1	PROTOCOLE / <i>PROTOCOL</i> .....	152
3.2	ENVIRONNEMENT SONORE / <i>ACOUSTIC ENVIRONMENT</i> .....	153
3.3	ÉCHANTILLONS ENREGISTRES / <i>RECORDED SAMPLES</i> .....	154
3.4	IDENTIFICATIONS ET ANALYSES / <i>IDENTIFICATION AND ANALYSES</i> .....	155
3.4.1	09 h 04 min 58 s : " <i>Bruit de sélecteur similaire au déplacement du Ground Idle Stop</i> " / " <i>Sound similar to the operation of the Ground Idle Stop Selector</i> " .....	158
3.4.2	09 h 05 min 00 s : " <i>Bruit similaire au soulèvement des Ground Range Selector</i> " / " <i>Sound similar to the lifting of the Ground Range Selector</i> " .....	161
3.4.3	09 h 05 min 09 s : " <i>Bruit similaire à la manoeuvre de la commande des flaps</i> " / " <i>Sound similar to the operation of flaps control</i> " .....	163
3.4.4	09 h 05 min 11 s : " <i>Bruit similaire à l'activation des Taxi Lights</i> " / " <i>Sound similar to Taxi Lights being switched on</i> " .....	165
3.4.5	09 h 05 min 19 s : " <i>Bruit</i> " / " <i>Noise</i> " .....	165
3.4.6	09 h 05 min 21 s : " <i>Bruit similaire à la manoeuvre de la commande des flaps</i> " / " <i>Sound similar to the operation of flaps control</i> " .....	169
3.4.7	09 h 05 min 27 s : " <i>Bruit</i> " / " <i>Noise</i> " .....	170
<b>4</b>	<b>CONCLUSION</b> .....	<b>171</b>

---

**CIRCONSTANCES / CIRCUMSTANCES**

Le 6 novembre 2002 à 9h05 UTC, un Fokker 50 exploité par Luxair immatriculé LX-LGB s'écrase lors de son approche sur l'aéroport de Luxembourg peu après s'être établi en finale ILS 24.

*On November 6, 2002 at 9.05 UTC time, a Fokker 50 operated by Luxair and registered LX-LGB crashes during the approach to Luxembourg just after establishing on ILS 24.*

**ENREGISTREURS / RECORDERS.**

Le Fokker 50 était équipé de deux enregistreurs de vol :

*The aircraft was equipped with two flight recorders:*

	<b>FDR</b>	<b>CVR</b>
<b>Model</b>	Fairchild F800	Fairchild A100A
<b>Part number (P/N)</b>	17M-800-251	93-A100-80
<b>Serial number (S/N)</b>	3672	56866



Les enregistreurs ont été lus le 7 novembre 2002 par un enquêteur technique du BEA (CF *Rapport d'Exploitation des Enregistreurs*).

*The Flight recorders were read out on November 7, 2002, at the BEA (See Flight Recorders Report).*

**essais complémentaires / additional tests**

Le rapport d'exploitation des enregistreurs concluait sur la nécessité de réaliser des essais complémentaires avec l'aide de la compagnie. Ces essais ont été effectués entre le 31 mars

---

et le 1<sup>er</sup> avril 2003 à Luxembourg avec des membres de la commission d'enquête, assistés par un pilote de Fokker 50.

Leur but est de pouvoir valider les hypothèses émises lors de la transcription des bruits et alarmes présents sur le CVR de l'avion accidenté.

*The flight recorders report concluded there was a need to proceed with additional tests with the assistance of the Airline. These tests were performed between March 31<sup>st</sup> and April 1<sup>st</sup>, 2003, in Luxembourg with members of the investigation commission, assisted by a Fokker 50 pilot.*

*The aim was to validate the hypotheses based on the transcription of the noises and alarms recorded on the CVR.*

#### Protocole / Protocol

Afin de pouvoir recréer des conditions similaires au vol de l'accident, plusieurs séries d'essais ont été réalisées :

- Le même type d'enregistreur (un A100-A à bande magnétique) était utilisé sur tous les avions ayant servis aux tests. C'est également ce type d'enregistreur qui équipait l'avion accidenté.
- Un vol a été fait sur le Fokker 50 immatriculé LX-LGC de la compagnie Luxair entre Paris et Luxembourg avec un enquêteur technique du BEA présent en poste
- A l'issue de ce vol, le CVR a été prélevé pour lecture des données et analyse des bruits et alarmes.
- Le même appareil a été utilisé pour un enregistrement des essais au sol.
- Enfin, les mêmes essais ont été enregistrés dans le Fokker 50 LX-LGD au sol afin de comparer les résultats avec un panel plus large d'appareils.
- Lors des essais en poste, le conditionnement d'air était opérant pour recréer le principal bruit de fond entendu généralement sur un CVR.
- Les manipulations ont été réalisées plusieurs fois sur chaque appareil afin de bénéficier d'un plus grand nombre d'éléments de comparaison.

*In order to reproduce similar conditions to those during the accident, several tests were performed:*

- *The same type of CVR (a magnetic tape A100-A) was used on every aircraft used to perform the tests. This was also the type of CVR installed on the crashed aircraft.*
- *A Luxair Fokker 50 registered LX-LGC flew from Paris to Luxembourg with a safety investigator present in the cockpit.*
- *Following this flight, the CVR was removed from the aircraft for read out and analysis*

*of noises and alarms.*

- *The same aircraft was used for a ground recording of the tests.*
- *Finally, the same tests were recorded in the Fokker 50 LX-LGD on the ground in order to compare the results with a wider range of aircraft.*
- *During the tests, the air conditioning was turned on to recreate the main background noise generally heard on CVRs.*
- *Tests were performed several times on each aircraft in order to compare the transcribed noises with several samples.*

#### Environnement sonore / *Acoustic environment*

Les essais ayant été réalisés au sol, il n'y a aucun bruit aérodynamique ni de bruit de moteur. Cette différence n'entame cependant en rien la validité des résultats car les bruits aérodynamiques sont des bruits large bande que l'on retrouve sur tout le spectre. Ils ne modifient pas la signature spectrale du bruit étudié. Les moteurs de l'avion quant à eux ont une signature spectrale connue que l'on peut donc discriminer par rapport au bruit analysé.

*Since the tests were carried out on the ground, there were neither aerodynamic noises nor engine noises. This difference, though, does not affect the validity of the results in so far as aerodynamic noises have a broad-band signature visible on the whole analysed spectrum. Thus, they do not modify the spectral signature of the analysed noise. Regarding the aircraft's engines, their signature was known and could thus be discriminated from the targeted noise.*

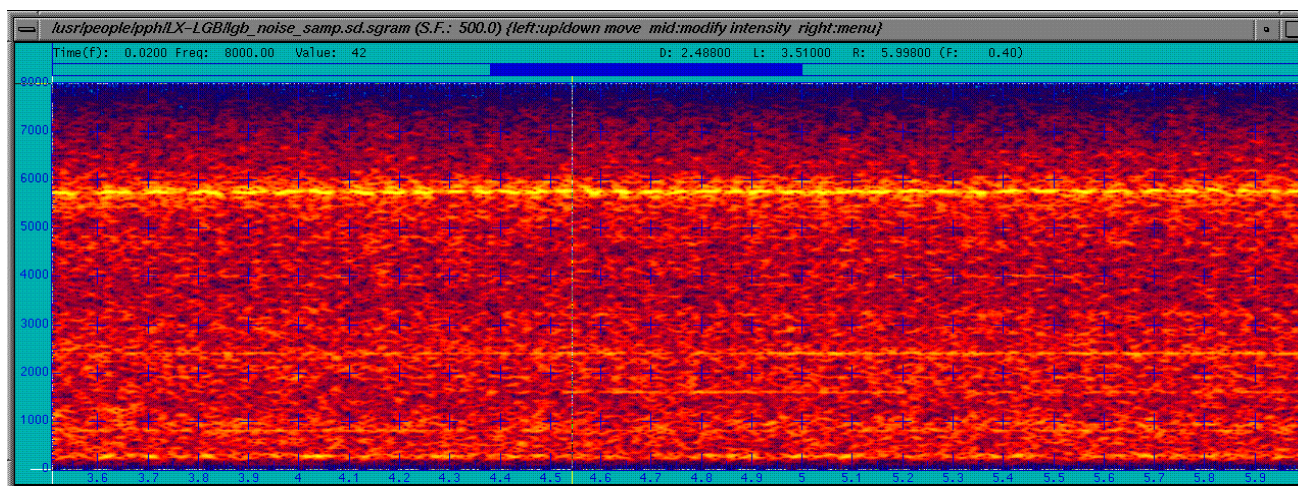

**Fig. 1: Représentation Temps – Fréquence du bruit de fond du LX-LGB en vol. Time – Frequency representation of the background noise on LX-LGB in flight.**

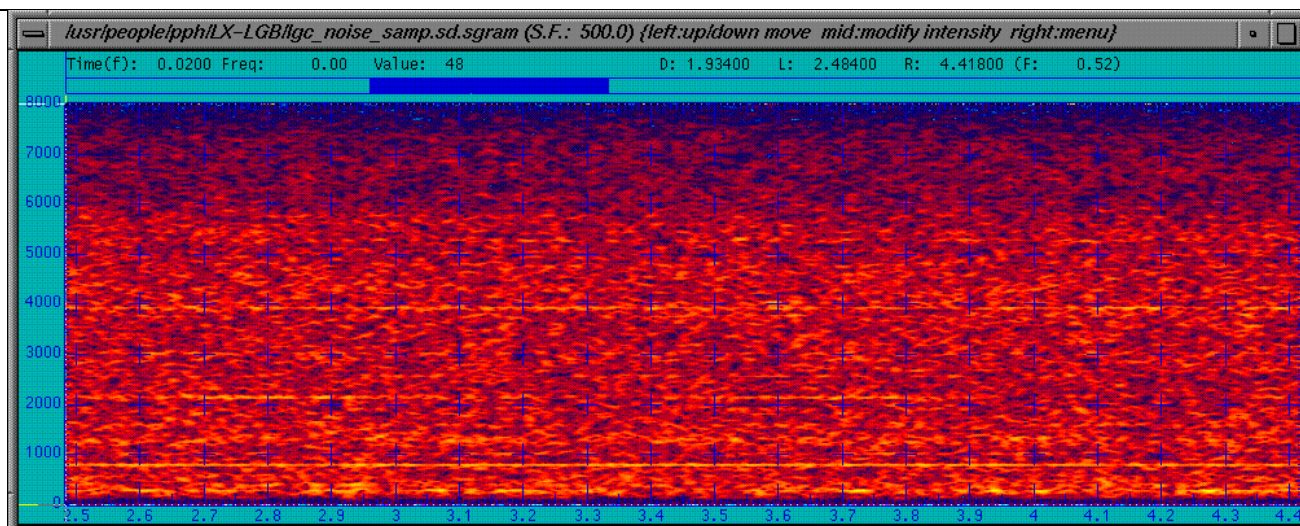

**Fig. 2: Représentation Temps – Fréquence du bruit de fond du LX-LGC au sol. Time – Frequency representation of the background noise on LX-LGC on the ground.**

Comme l'illustrent les deux figures précédentes, le LX-LGB (fig. 1) présente un signal plus bruité que celui du LX-LGC (fig. 2). Les hautes fréquences (autour de 5700 Hz) correspondent au bruit de la turbine de l'avion. Le bruit de fond est globalement plus élevé en raison du bruit aérodynamique caractérisé par un spectre large bande.

*As shown in the previous figures, LX-LGB in flight (Fig.1) shows a signal with more noise than on LX-LGC on the ground (fig.2). Higher frequencies (around 5,700 Hz) match with the turbine noise whereas the global background noise has a wide range spectrum, consistent with aerodynamic noise.*

#### Échantillons enregistrés / Recorded Samples

La liste suivante recense une sélection de bruits générés dans le poste de pilotage du Fokker 50. Cette sélection a été faite en concertation avec les membres de la commission d'enquête.

*The following list summarizes a selection of noises and alarms generated in the cockpit of the Fokker 50. This selection has been done with the members of the investigation commission.*

- Manœuvre de la commande des volets / *Flap selector operation,*
- Manœuvre de la manette des gaz / *Throttle operation,*
- Déplacement du siège dans 3 directions / *Seat motion in 3 directions,*
- Utilisation des accoudoirs / *Use of armrest,*
- (Dés)-activation des Taxi lights / *Taxi lights switching,*
- (Dés)-activation des Landing lights / *Landing lights switching,*
- (Dés)-activation de la Compass light / *Compass light switching,*
- (Dés)-activation du voyant cabine "Seat Belts On" / *"Seat Belts On" light switching,*
- Génération de l'alarme GPWS / *GPWS alarm generation,*
- Génération du Double et Triple Chime / *Double and Triple Chime generation,*
- Mouvements d'objets en poste / *Objects moving in the cockpit,*
- Ouverture et fermeture de la porte / *Door opening and closing.*

## Identifications et analyses / *Identification and analyses*

Les paragraphes suivants rapportent les résultats des essais et les analyses de comparaison des signaux entre l'enregistrement du CVR accidenté et les enregistrements des essais. La méthodologie employée sera décrite en détail dans l'exemple suivant, les autres identifications reprenant le même principe. Ces identifications suivront l'ordre dans lesquels les bruits ont été transcrits, i.e. chronologiquement.

*The following paragraphs report the results of the tests and comparison analyses between the recording of the accident CVR and the tests recording. A first example will be thoroughly explained, the other identifications following the same principle. The noises and alarms identification will follow the order in which they were transcribed, i.e. chronologically.*

Exemple de l'identification de l'activation des *Taxi Lights* / *Taxi Lights Identification example*:

Afin de valider le bruit transcrit, l'analyse spectrale de ce dernier est comparée avec celles des différents essais enregistrés dans les autres avions. Pour accroître les probabilités et la fiabilité des identifications, il convient d'en comparer plusieurs aspects.

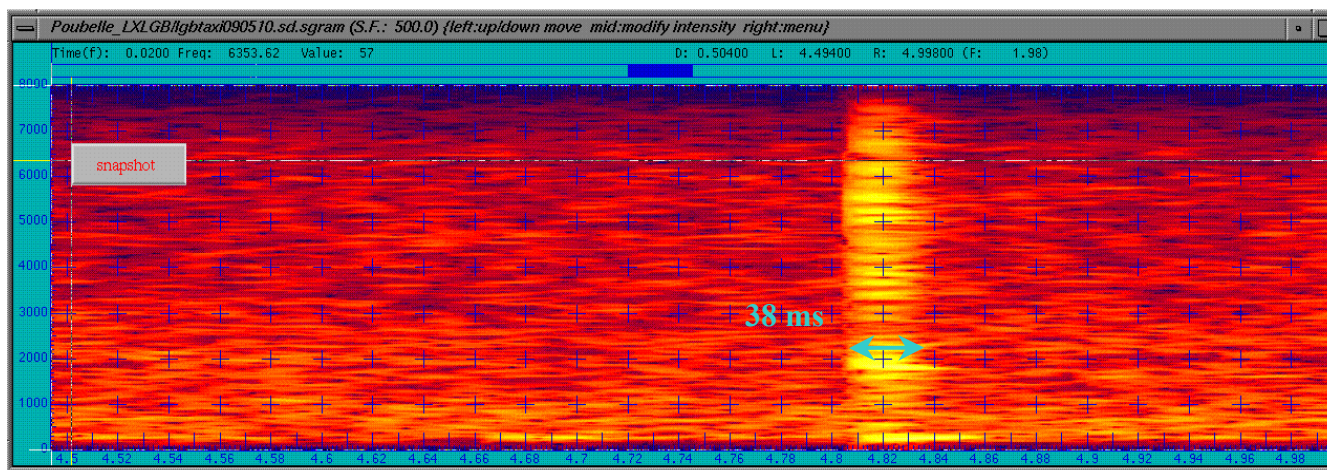

**Fig. 3:** *Représentation Temps – Fréquence du bruit transcrit. Time – Frequency representation of the transcribed noise.*

La figure ci-dessus représente le bruit enregistré sur le CVR de l'accident et transcrit comme l'activation des taxi lights. La figure suivante représente un enregistrement du bruit généré par l'activation des taxi lights lors des essais au sol.



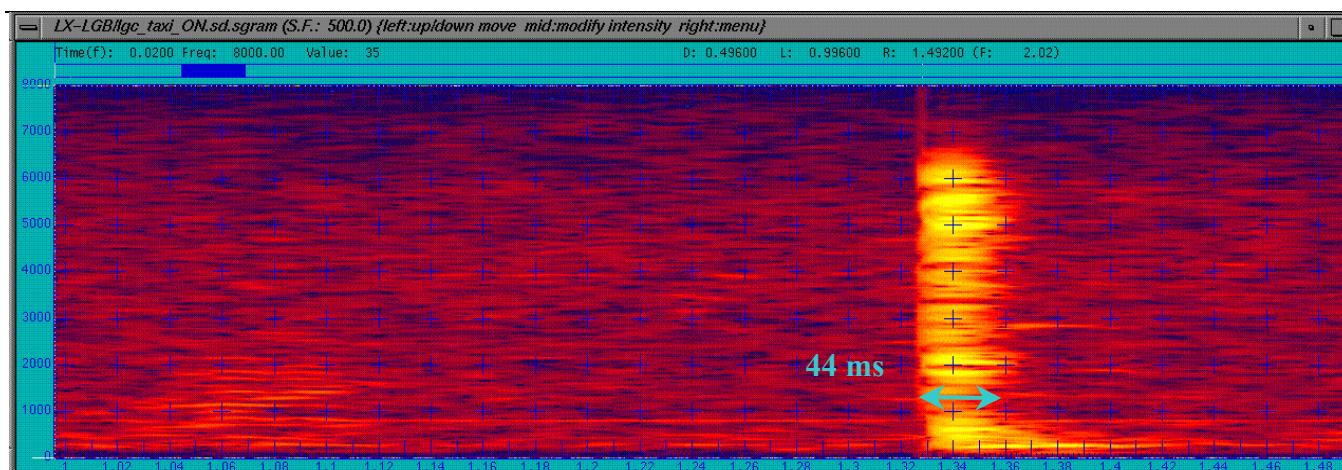

**Fig. 4:** Représentation Temps-Fréquence du bruit généré. **Time – Frequency representation of the generated noise.**

#### **Le domaine temporel : / The time domain:**

L'analyse du signal dans ce domaine consiste à mesurer la durée du signal global et sa cadence si le bruit se décompose en plusieurs parties.

*The signal analysis consists in measuring the global signal duration and its cadence if the noise can be decomposed in several parts.*

Dans cet exemple on a : / *In this example, we have:*

Durée du bruit transcrit / *Duration of the transcribed noise:* **38 ms**

Durée du bruit généré / *Duration of the generated noise:* **44 ms**

#### **Le domaine fréquentiel : / The frequency domain:**

L'analyse se fait ici sur la répartition des pics d'énergie selon la gamme de fréquence étudiée et sur la forme du signal. Cette dernière est définie par les durées respectives de chaque fréquence caractéristique du bruit étudié. Ainsi dans l'exemple étudié, on retrouve dans les deux représentations une composante basse fréquence plus longue que les autres fréquences. Cela est dû au montage de l'interrupteur sur le panneau supérieur du cockpit. A cet emplacement, une cavité existe sous le panneau supérieur et l'air qu'elle contient entre en vibration, expliquant cette composante basse fréquence.

*The analysis is here done on the energy distribution over the range of frequencies studied and the shape of the signal. The latter is defined by the respective duration of each specific frequency of the analysed noise. Thus, in this example, both representations feature a low frequency peak longer than the other frequencies. This is due to the position of the switch on the over-head panel. At this location, a cavity exists below the panel and the air contained starts to vibrate, explaining this low frequency peak.*

Les courbes ci-après constituent une coupe verticale de la représentation temps - fréquence décrite plus haut. On peut y voir à un instant donné (pris au milieu du bruit) les fréquences qui caractérisent le bruit analysé. On s'attache ici à la **répartition** des pics d'énergie pour identifier le bruit.

*The graphs here-after are a vertical view of the time – frequency representation described*

above. They show, at a given time (taken in the middle of the noise), the frequencies that define the analysed noise. The **distribution** of these energy peaks is significant in identifying the noise.

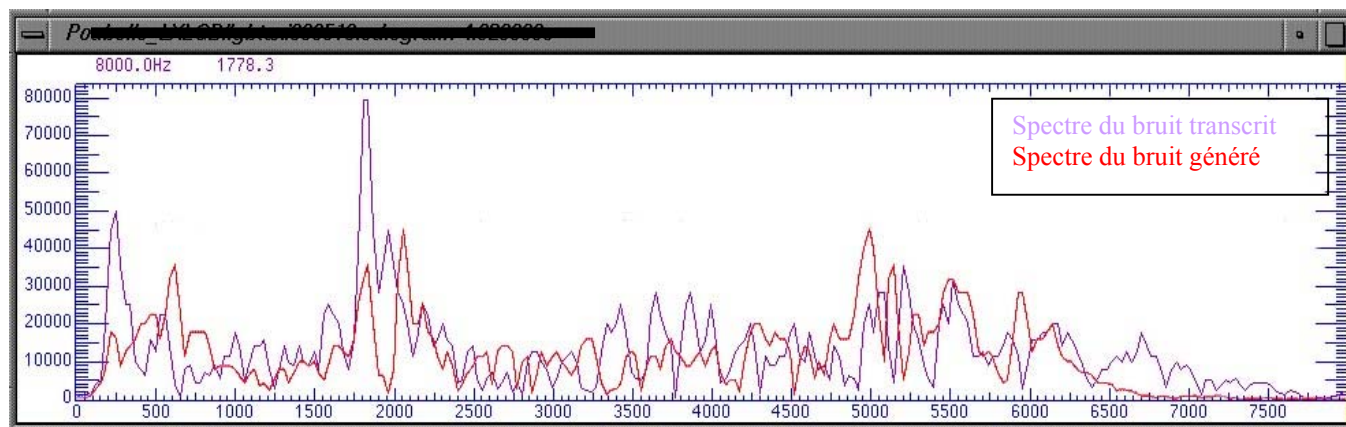

**Fig. 5: Comparaison des composantes fréquentielles des bruits transcrit (en mauve) et généré (en rouge). Spectrum comparison between the transcribed noise (in mauve) and the generated noise (in red)**

On retrouve les mêmes composantes fréquentielles, notamment aux basses fréquences et autour de **2000** et **5000** Hz.

*As seen in figure 14, the same frequencies are visible, especially for low frequencies and around 2000 and 5000 Hz.*

On conclut donc ici à l'identification positive de **l'allumage des Taxi Lights**.

*We can thus draw a positive conclusion on the identification of the **Taxi Lights turned On**.*

Par ailleurs, ces résultats sont à rapprocher de la phase de vol au cours de laquelle ces bruits interviennent et des procédures de vol qui prévoient, tous dysfonctionnements mis à part, les actions sur les instruments et manettes de l'aéronef.

*Moreover, those results have to be compared with the period of the flight during which they occur and with expected flight procedures, assuming no malfunction occurred.*

Enfin, il convient de prendre en compte dans ces analyses la perception de l'oreille humaine, assimilable à un puissant analyseur permettant de compiler tous les aspects précédemment développés et de reconnaître, par expérience et par simple écoute, le bruit d'un interrupteur. Ce facteur a une place importante dans l'analyse.

*Finally, it should be taken into account the human perception of the hear, comparable to a powerful analyser which can compile all the previously described aspects and can recognize, by experience and through a single listening, the noise of a switch. This factor has an important part in the analysis.*

Il est important de noter que dans ces analyses, il ne peut être tenu compte des intensités respectives des signaux transcrit et généré. En effet, les fonctions de contrôle automatique du gain atténuent le signal lorsque le bruit de fond est plus important afin d'éviter une saturation du signal. On ne peut donc pas raisonner sur les valeurs absolues de ces intensités.

*It is important to note in these analyses that the respective intensities of the transcribed and the generated noises cannot be taken into account. Indeed, the automatic gain control functions attenuate the signal when the background noise is important in order to prevent the signal overload. We thus cannot analyse the absolute values of those intensities.*

**NB :** Ce rapport présente les comparaisons entre un enregistrement du CVR accidenté et un enregistrement d'essai. Il convient de noter que ces analyses ont été faites pour les deux avions ayant servis aux test et permettent de confirmer que les manœuvres d'une même commande produisent sur les deux avions différents des résultats similaires

**N.B.:** *This report present the comparison between a recording of the accident CVR and one recording of the tests. It should be noted that these analyses were performed for both aircrafts and showed that the same command on the two different aircraft produced similar results.*

**09 h 04 min 58 s : "Bruit de sélecteur similaire au déplacement du Ground Idle Stop" / "Sound similar to the operation of the Ground Idle Stop Selector"**

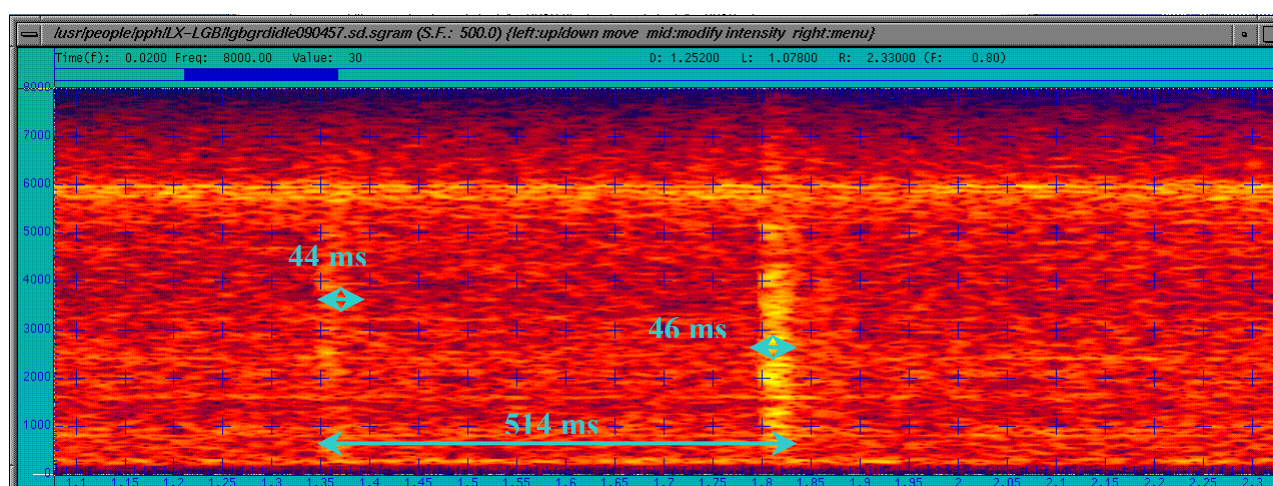

**Fig. 6: Représentation Temps – Fréquence du bruit transcrit. Time – Frequency representation of the transcribed noise.**

La figure précédente représente le bruit à analyser dans le domaine temps-fréquence. L'axe horizontal y représente le temps, l'axe vertical les fréquences, et un code de couleur l'énergie du signal (le bleu représentant les faibles énergies, le jaune ou blanc les plus fortes).

*The previous figure represents the noise to be analysed in the time-frequency domain. The horizontal axis represents the time, the vertical axis the frequencies, and a colour code the energy of the signal (blue being the lowest energies, yellow or white the highest).*

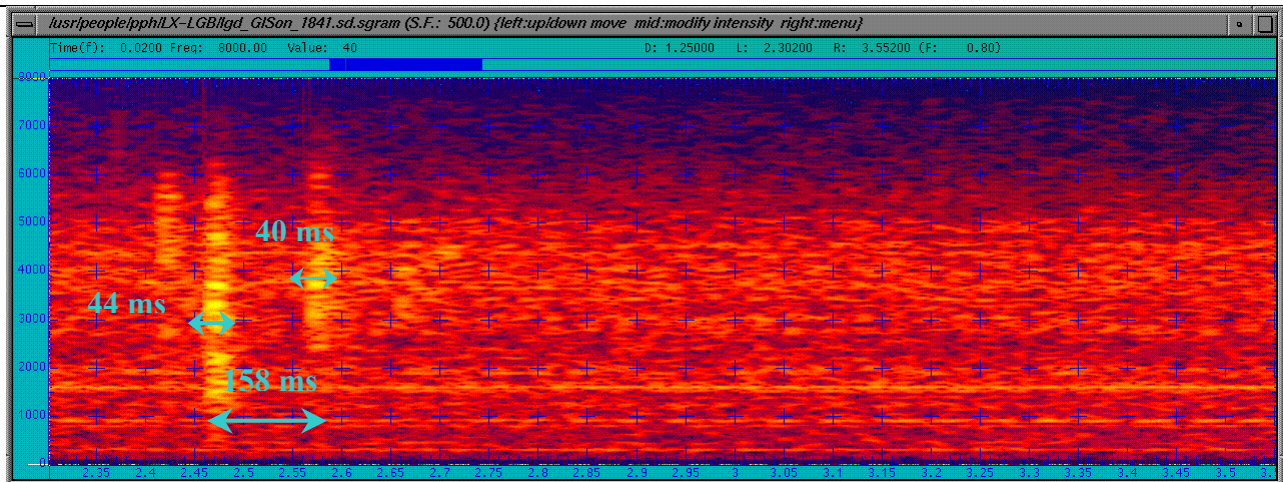

**Fig. 7: Représentation Temps-Fréquence du bruit généré. Time – Frequency representation of the generated noise.**

La figure précédente représente le bruit du déplacement du *Ground Idle Stop* vers la position OFF, dans le domaine temps- fréquence.

*The previous figure represents the noise of the Ground Idle Stop selector set to OFF, in the time-frequency domain.*

Dans le cas présent, les deux bruits ont une forme similaire et peuvent se décomposer en 2 parties. **Cette forme est a priori cohérente avec l'hypothèse de la manœuvre du sélecteur en question** (le *Ground Idle Stop*). En effet, manipuler ce sélecteur suppose sa levée d'une butée, sa translation puis son ré-enclenchement dans sa nouvelle position, d'où le double bruit. Cette cinématique est la seule à produire ce double bruit, à l'exception de la manœuvre des commandes de gaz, des volets et du train d'atterrissage. Ces deux dernières commandes cependant ont une signature spectrale bien différente que l'on ne peut confondre avec le bruit analysé ici.

*In the present case, both noises have a similar shape and can be defined as the conjunction of two shorter noises. **This shape is consistent with the hypothesis of an action on the selector in question** (Ground Idle Stop). In fact, moving this selector requires lifting it from its initial position, transferring it and then dropping it into its new position, which explains the double noise. This sequence of operations is the only one which produces this double noise, apart from the throttle, the flaps selector and landing gear levers. However, the two latter controls have quite different spectral signatures that cannot be confused with the noise analyzed here.*

#### **Analyse temporelle / Time analysis :**

La durée de ces bruits est du même ordre de grandeur : 44 et 46 ms pour le LX-LGB, et 44 et 40 ms pour le LX-LGD. A noter que la durée entre ces deux clics peut être facilement modifiée par la cinématique décrite ci-dessus.

*The duration of these noises is about the same: 44 and 46 ms for the LX-LGB, and 44 and 40 ms for the LX-LGD. It should be noted that the duration between the two clicks can be easily*

modified due to the particular sequence of operations previously described.

### Analyse fréquentielle / Frequency analysis :

Les courbes ci-après constituent une coupe verticale de la représentation temps - fréquence décrite plus haut. On peut y voir à un instant donné (choisi au milieu du bruit) les fréquences qui caractérisent le bruit analysé. On s'attache ici à la **répartition** des pics d'énergie pour identifier le bruit.

The graphs here-after are a vertical view of the time – frequency representation described above. They show, at a given time (taken in the middle of the noise), the frequencies that define the analysed noise. The **distribution** of these energy peaks is significant in identifying the noise.

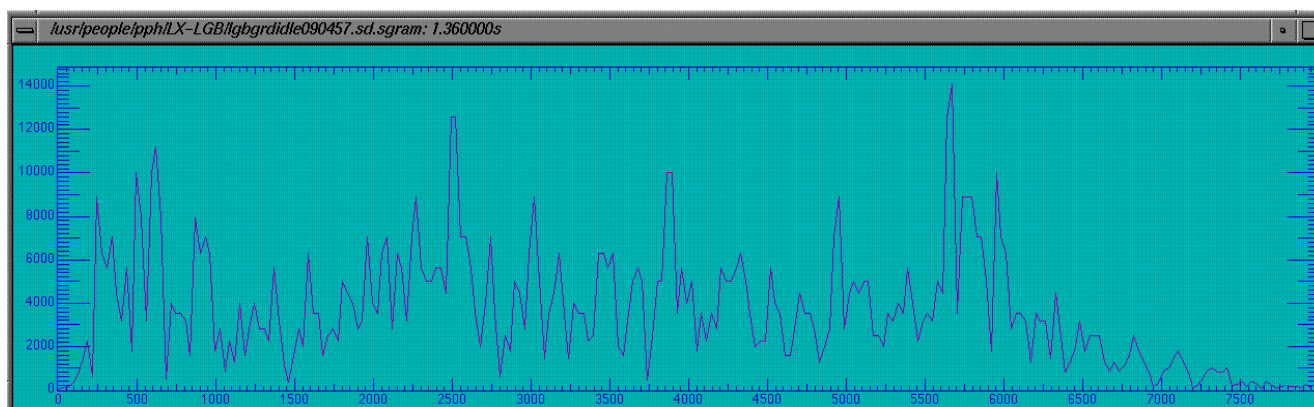

**Fig. 8: Représentation Fréquentielle du bruit à identifier. Frequency representation of the noise to be identified.**

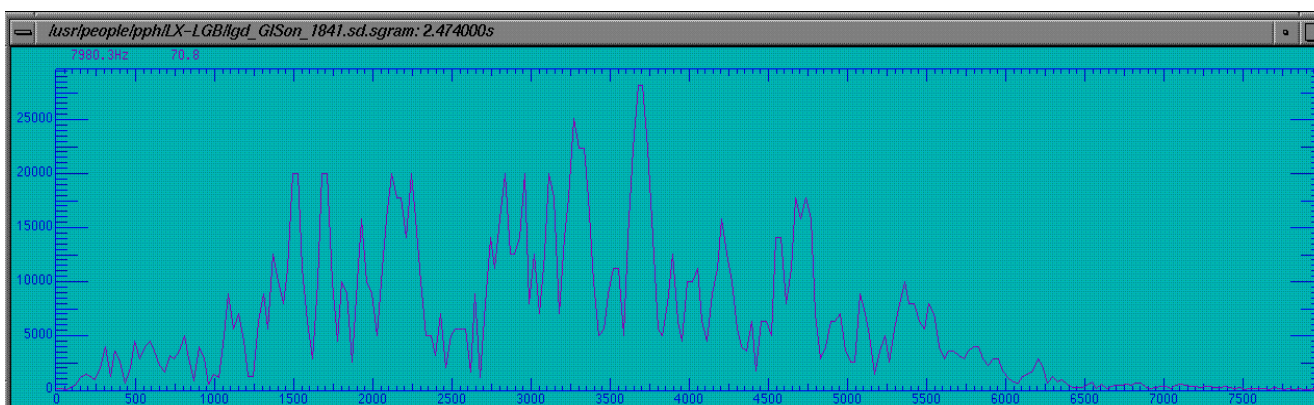

**Fig. 9: Représentation Fréquentielle du bruit généré. Frequency representation of the generated noise.**

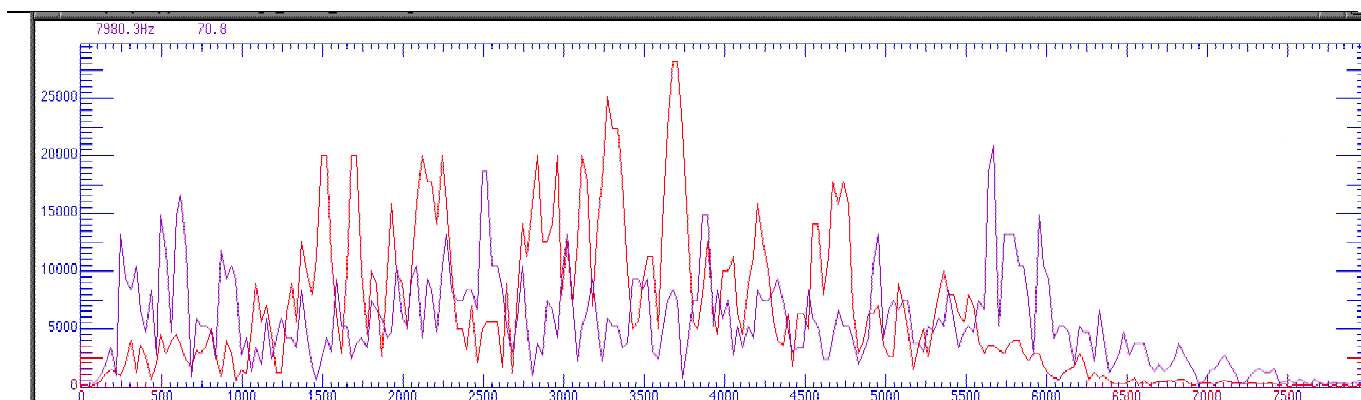

**Fig. 9bis : Comparaison des composantes fréquentielles des bruits transcrit (en mauve) et généré (en rouge). Spectrum comparison between the transcribed noise (in mauve) and the generated noise (in red)**

Comme expliqué précédemment, les figures 5 et 6 illustrent les différences de bruit de fond entre les deux CVR. Dans le cas du LX-LGB, le spectre est plus large en raison des bruits aérodynamique et des moteurs.

Cependant, on reconnaît des correspondances entre les deux spectres, notamment de **1500 à 2500 Hz** et entre **4500 et 5000 Hz**.

*As explained above, figures 5 and 6 show the difference in the background noise between the two CVRs. In the case of LX-LGB, the spectrum is wider due to aerodynamic and engine noises.*

*However, some frequencies match between the two spectrums, especially from **1,500 to 2,500 Hz**, and between **4,500 and 5,000 Hz**.*

Au vu des éléments décrits ci-dessus, il apparaît donc **probable** que la commande actionnée soit celle du Ground Idle Stop mis sur Off.

*Given the data described above, it seems **likely** that the selector that was selected was the Ground Idle Stop command set to Off.*

### **09 h 05 min 00 s : "Bruit similaire au soulèvement des *Ground Range Selector*" / "Sound similar to the lifting of the *Ground Range Selector*"**

Ce bruit est généré lorsque, à partir de la position *Flight Idle* des deux manettes de puissance, le pilote soulève les deux leviers du *Ground Range Selector*, permettant le passage du cran amenant ces deux manettes en plage "Béta". Un bruit se fait entendre pour chaque levier, gauche et droit. Cependant, lorsque la manœuvre est faite pour les deux côtés en même temps, ces deux bruits sont alors confondus en un seul.

*This noise is generated when, from the Flight Idle position of the throttles the pilot has to lift two levers called *Ground Range Selector* permitting the movement of the throttles into the Beat range. A noise can be heard for each lever, left and right. However, when the operation is done simultaneously for both sides, the two noises appear to be one.*

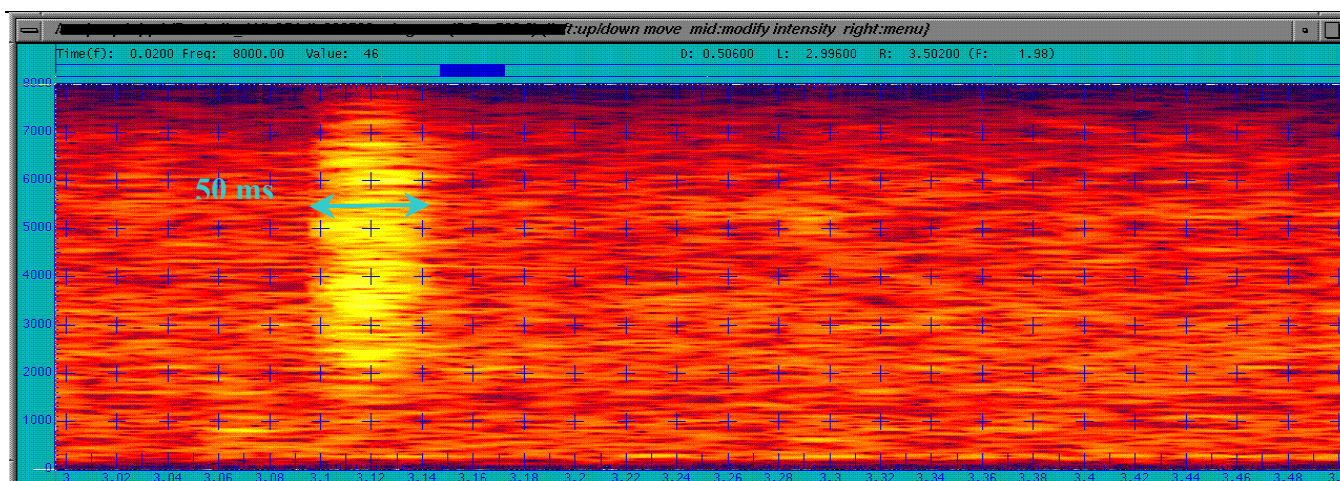

**Fig. 10: Représentation Temps – Fréquence du bruit transcrit. Time – Frequency representation of the transcribed noise.**

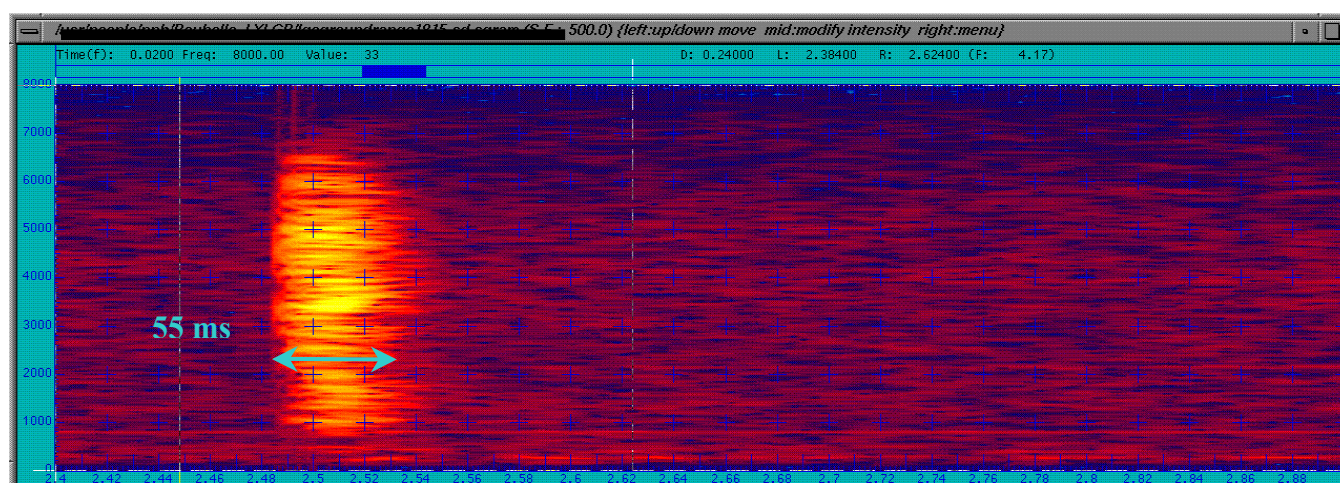

**Fig. 11: Représentation Temps-Fréquence du bruit généré. Time – Frequency representation of the generated noise.**

La figure ci-dessus représente le bruit du déplacement des *Ground Range Selector* dans le domaine temps - fréquence dans le cas où les deux leviers sont soulevés simultanément afin de retrouver une forme semblable à celle obtenue avec le bruit transcrit.

*The above figure represents the noise made by the operation of the Ground Range Selector when the two levers are lifted at the same time in order to obtain a shape similar to the transcribed noise.*

#### **Analyse temporelle / Time analysis :**

Durée du bruit transcrit / *Duration of the transcribed noise: 50 ms*

Durée du bruit généré / *Duration of the generated noise: 55 ms*

#### **Analyse fréquentielle / Frequency analysis :**

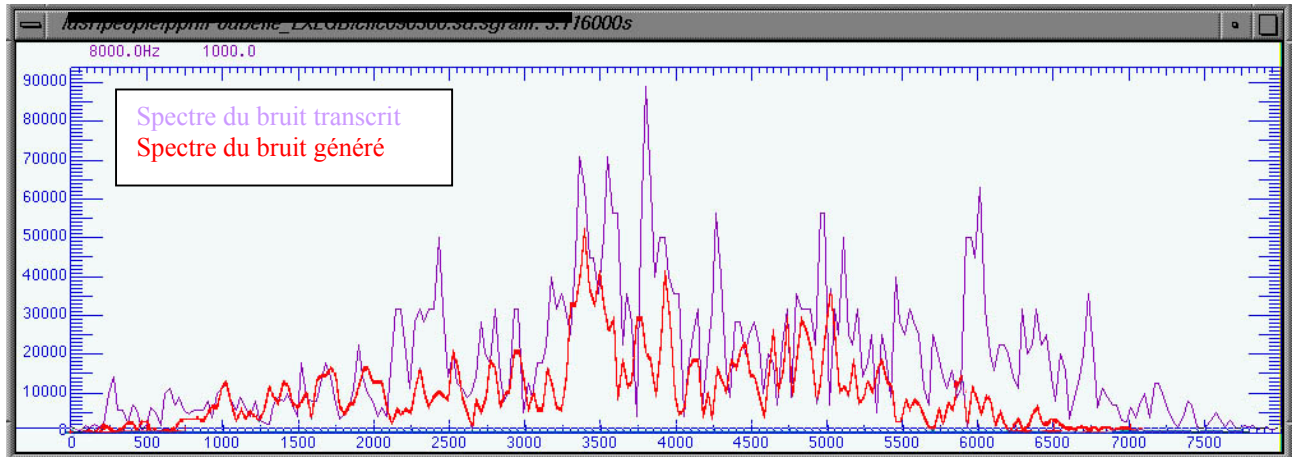

**Fig. 12: Comparaison des composantes fréquentielles des bruits transcrit (en mauve) et généré (en rouge). Spectrum comparison between the transcribed noise (in mauve) and the generated noise (in red)**

La figure ci-dessus est une superposition des représentations fréquentielles du bruit transcrit et du bruit généré. Les intensités du spectre du bruit transcrit apparaissent logiquement supérieures à celles du bruit généré (voir paragraphe 3.2 *Environnement sonore / Acoustic environment*). On constate ainsi que les deux spectres sont très proches. On rappelle que les pics entre 5500 et 6000 Hz proviennent du fonctionnement du turbopropulseur.

*The above figure is a superimposition of 2 spectra from the transcribed noise and the generated noise. The spectrum intensity for the transcribed noise is logically higher than for the generated noise (See paragraph 3.2 *Environnement sonore / Acoustic environment*). Thus, both spectra are very similar. As a reminder, the peaks between 5,500 and 6,000 Hz come from the operation of the turboprop.*

On peut donc conclure, en raison de la meilleure concordance des spectres de fréquences, que bruits transcrit et généré sont identiques : il s'agit du **soulèvement des leviers du Ground Range Selector**.

*We can thus conclude, based on better matching between the frequency spectra, that the transcribed and the generated noises are the same: it is the **lifting of the two Ground Range Selector levers**.*

**09 h 05 min 09 s : "Bruit similaire à la manoeuvre de la commande des flaps" / "Sound similar to the operation of flaps control"**

Ce bruit intervient alors que l'équipage vient de mentionner la position des volets. A la suite de cette annonce et de ce bruit, les données du FDR indiquent un déploiement des volets vers la position dix degrés.

*This noise occurs as the crew members talk about the flaps position. After this communication and this noise, the FDR data show that the flaps extended to ten degrees.*



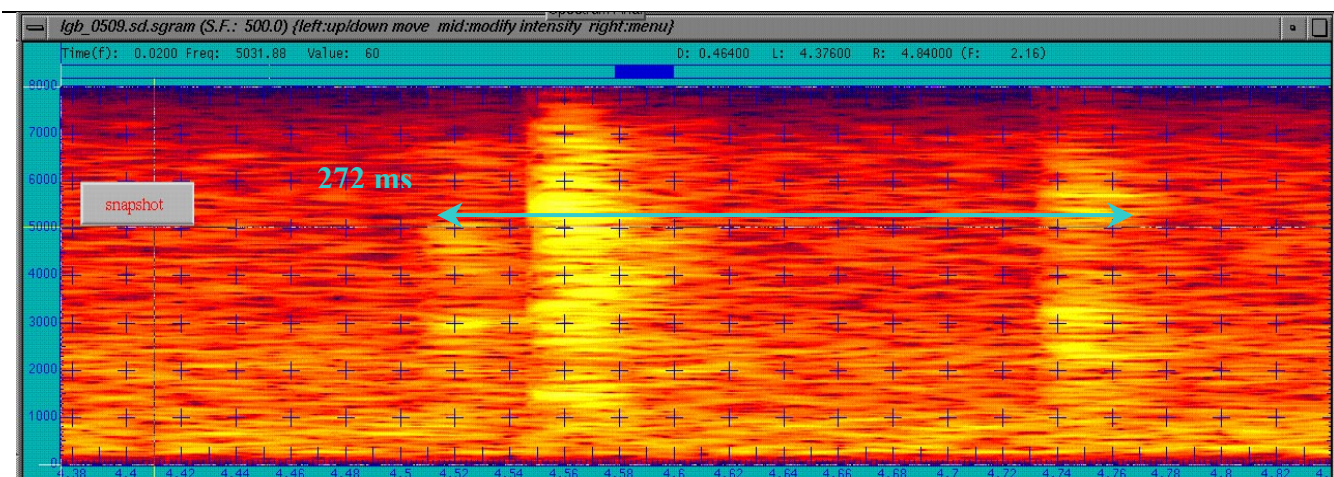

**Fig. 13: Représentation Temps – Fréquence du bruit transcrit. Time – Frequency representation of the transcribed noise.**

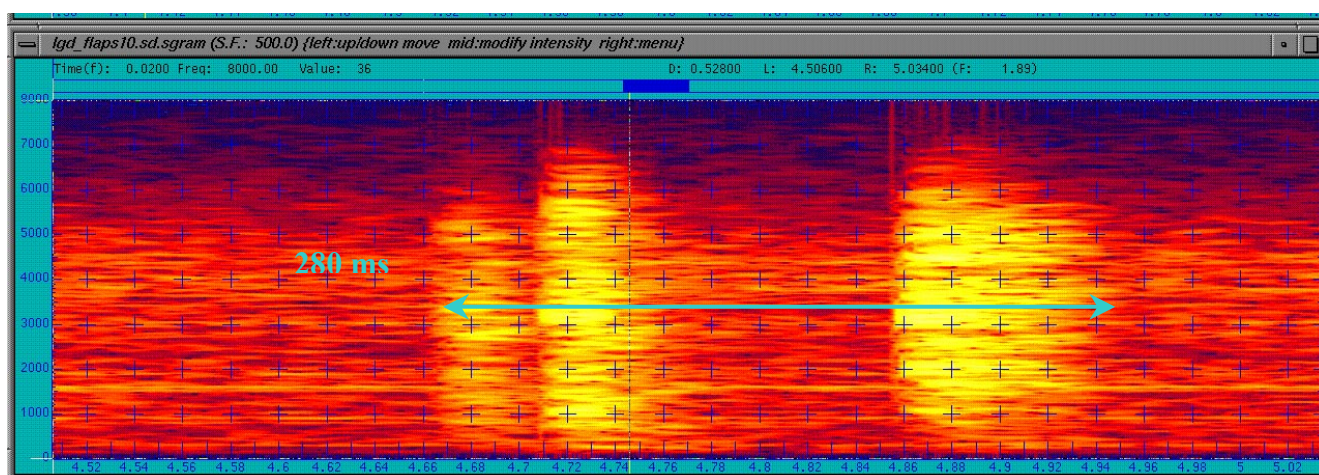

**Fig. 14: Représentation Temps-Fréquence du bruit généré. Time – Frequency representation of the generated noise.**

### **Analyse temporelle / Time analysis :**

Durée du bruit transcrit / *Duration of the transcribed noise:* **272 ms**

Durée du bruit généré / *Duration of the generated noise:* **280 ms**

Les figures précédentes illustrent les similitudes existant entre les deux bruits, où l'on retrouve la même forme de signature, les mêmes cadences.

*The preceding figures illustrate the similarities between the two noises, where the same signature shape and rates are found.*

### **Analyse fréquentielle / Frequency analysis :**

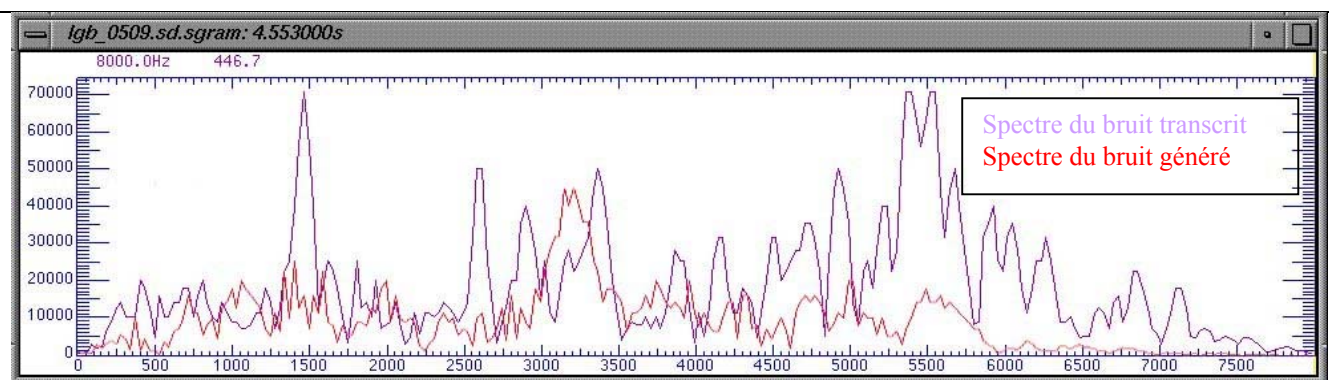

**Fig. 15:** Comparaison des composantes fréquentielles des bruits transcrit (en mauve) et généré (en rouge). **Spectrum comparison between the transcribed noise (in mauve) and the generated noise (in red)**

Bien que moins évidents, les résultats de la figure ci-dessus permettent de retrouver les points communs entre les deux bruits, notamment autour de **3250, 3800, 5000 et 5500 Hz**.

*Though not as clearly as in previous examples, the above figure shows the similarities between the two noises, especially around **3250, 3800, 5000 and 5500 Hz**.*

Tous les éléments précédents (durée, cadence, faciès, répartition des fréquences) permettent donc de conclure à **l'identification positive du bruit : le déplacement de la commande des volets**. Les données du FDR confirment un **déplacement vers la position dix degrés**

*All the previous elements (duration, rate, shape, distribution of frequencies) allow us to reach a conclusion about the **positive identification of the noise: the setting of the flaps control**. The FDR data confirm a **movement towards ten degrees**.*

**09 h 05 min 11 s : "Bruit similaire à l'activation des Taxi Lights" / "Sound similar to Taxi Lights being switched on"**

Voir l'exemple donné dans le paragraphe **3.4 Identifications et analyses / Identification and analyses**

**See the example given in paragraph 3.4 Identifications et analyses / Identification and analyses**

**09 h 05 min 19 s : "Bruit" / "Noise"**

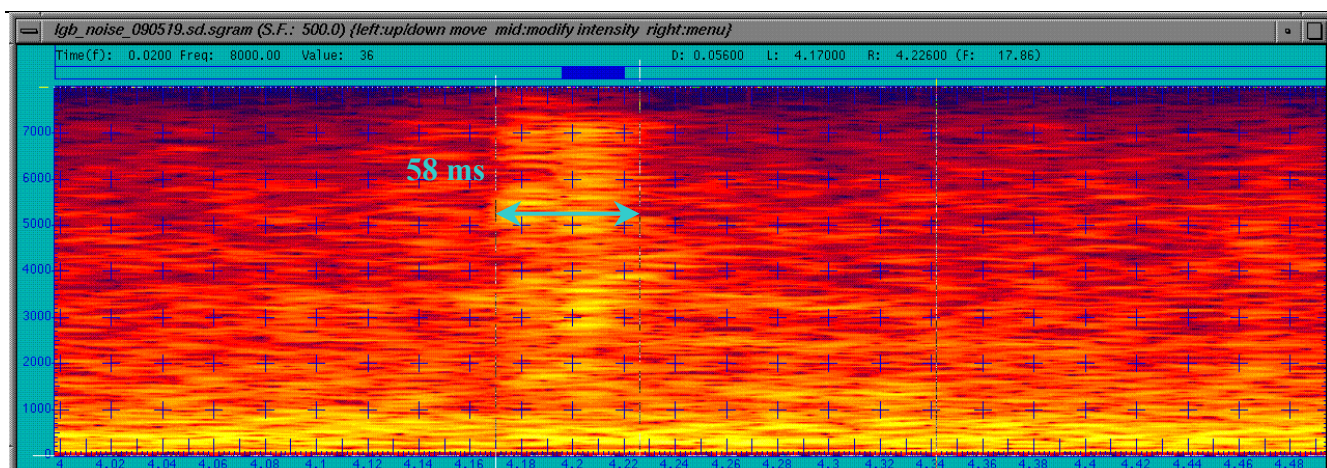

**Fig. 16:** *Représentation Temps - Fréquence du bruit à identifier). Time Frequency representation of the noise to be identified.*

Ce bruit peut se décomposer temporellement en deux parties correspondant à deux « clics » distincts mais très rapprochés. Sa durée totale est de **58 ms**.

*This noise can be decomposed temporally in two parts corresponding with two separate but adjacent noises. Its total duration is **58 ms**.*

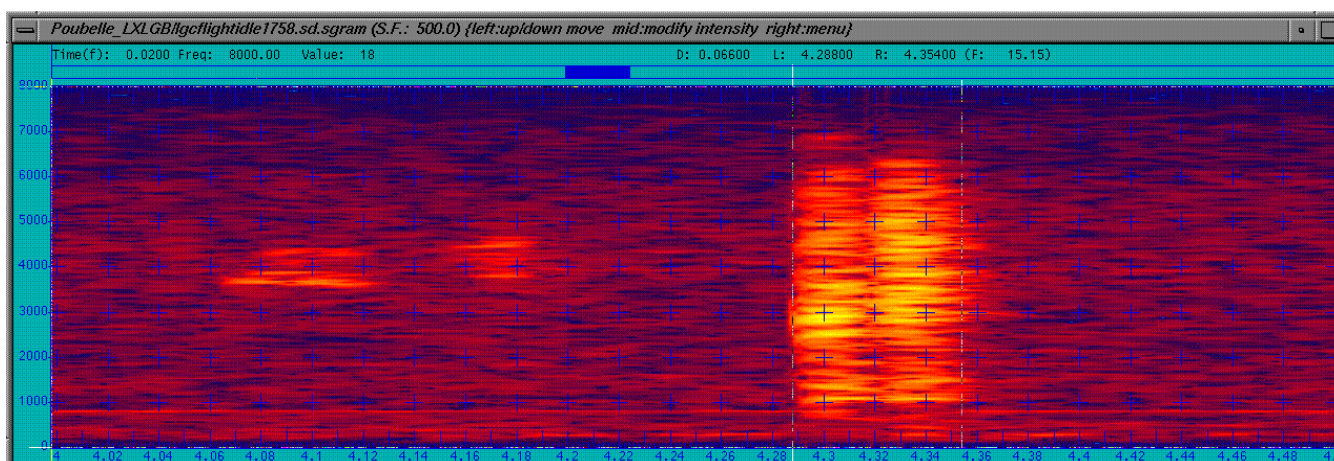

**Fig. 17:** *Représentation Temps - Fréquence du mouvement de la manette des gaz mise en position « Flight Idle ». Time Frequency representation of the operation of the throttle moved to « Flight Idle » position.*

La figure ci-dessus correspond à la manipulation des manettes des gaz sur le Fokker 50 immatriculé LX-LGC. Ces manettes étant en position *Ground Idle*, elles sont ramenées en position *Flight Idle*. On retrouve ici cette décomposition en deux clics distincts. La durée totale de ce bruit est de **70 ms**.

*The above figure corresponds to the movement of the thrust levers on the Fokker 50 registered LX-LGC. The thrust levers were moved to the Flight Idle position from the Ground Idle position. The same two separate clicks can be seen. The total duration of this noise was **70 ms**.*

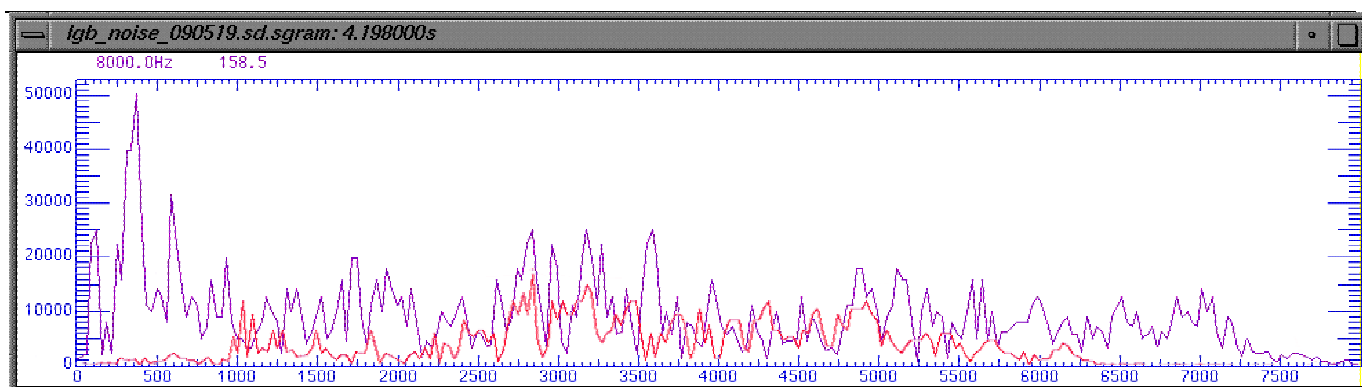

**Fig. 18:** Comparaison des composantes fréquentielles des bruits transcrit (en mauve) et généré (en rouge).  
**Spectrum comparison between the transcribed noise (in mauve) and the generated noise (in red)**

Le bruit à identifier est rapproché de celui de mouvement de la manette des gaz dans la mesure où ce dernier est cohérent avec le faciès du signal (deux clics). La figure ci-dessus illustre les fréquences communes à ces deux bruits (2800, 3200, 5000 Hz...). Il s'agit ici du déplacement des manettes des gaz vers la position *Flight Idle*.

*The noise to be identified is compared with that of the movement of the thrust levers in so far as the latter is consistent with the shape of the signal (two clicks). The above figure shows the common frequencies between these two noises (2800, 3200, 5000 Hz...). This represents the movement of the throttle levers to the Flight Idle position.*

Une deuxième comparaison du bruit transcrit avec un autre mouvement de manette donne des résultats comparables. En ramenant cette fois les manettes de gaz en position *Reverse*, on obtient les résultats suivants :

*A second comparison of the transcribed noise with another lever movement gives comparable results. By moving the throttle levers to the "Reverse" position, the following results are obtained:*

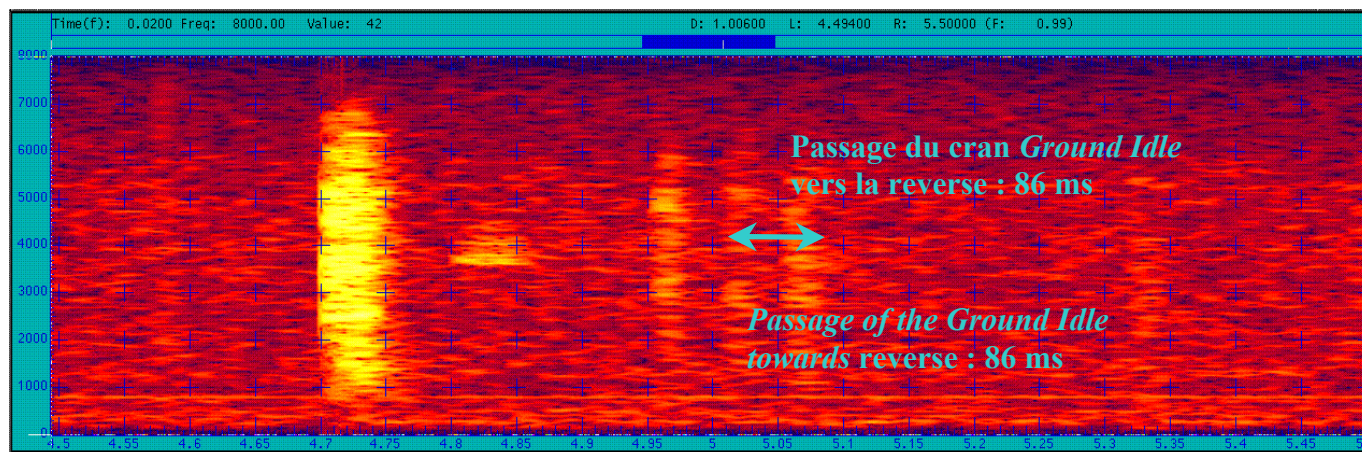

**Fig. 19:** Représentation Temps - Fréquence issue du mouvement de la manette des gaz mise en position « Reverse » depuis la position *Flight Idle*. **Time Frequency representation of the movement of the throttle from the Flight Idle position to the « Reverse » position.**

La figure ci-dessus illustre tout le mouvement des manettes de gaz de la position *Flight Idle* à la position *Reverse*. Les flèches indiquent le passage du cran *Ground Idle*.

*The previous figure shows the complete displacement of the thrust levers from the Flight Idle position to the Reverse position. The arrows indicate the passage of the Ground Idle position.*

S'agissant d'un mouvement de manette, on retrouve encore la même décomposition du bruit. Dans le cas présent, ce bruit est plus long que celui transcrit, avec les causes connues décrites au paragraphe 3.4.2. Les comparaisons des spectres donnent :

*Since this is a movement of a lever, the same double signature of the noise is obtained. In this case, this noise is longer than the one transcribed, the known causes being as described in section 3.4.2. The comparison of the spectra shows :*

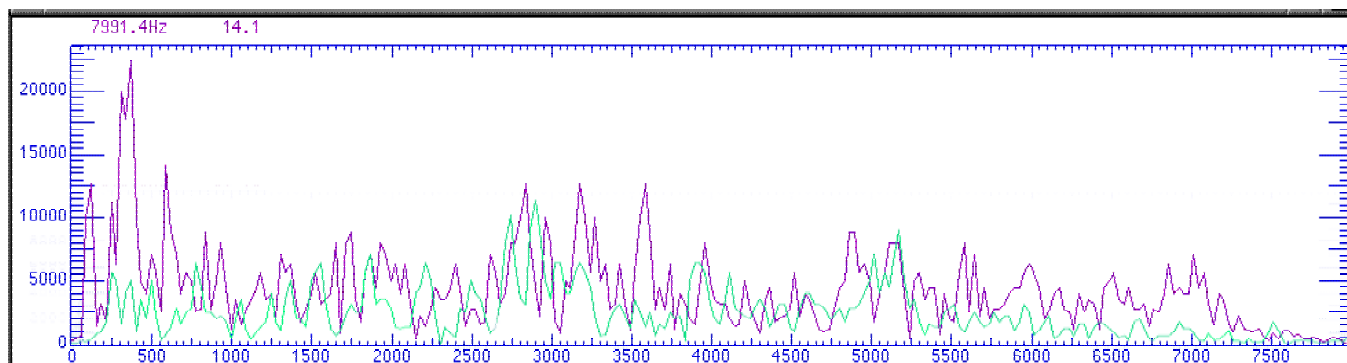

**Fig. 20: Comparaison des composantes fréquentielles des bruits transcrit (en mauve) et generé (en vert). Spectrum comparison between the transcribed (in mauve) and the generated noise (in green)**

Là encore, les spectres présentent des similitudes autour de 700, 1500, 3200, 4000 Hz, ... C'est pourquoi les deux précédents bruits testés ont été comparés entre eux afin d'établir une identification différentielle. On obtient alors les résultats de la figure suivante.

*Here again, both spectra show similarities around 700, 1500, 3200, 4000 Hz... This is why the two previous noises tested were compared with each other in order to obtain a differential identification. The results in the figure below were thus obtained.*

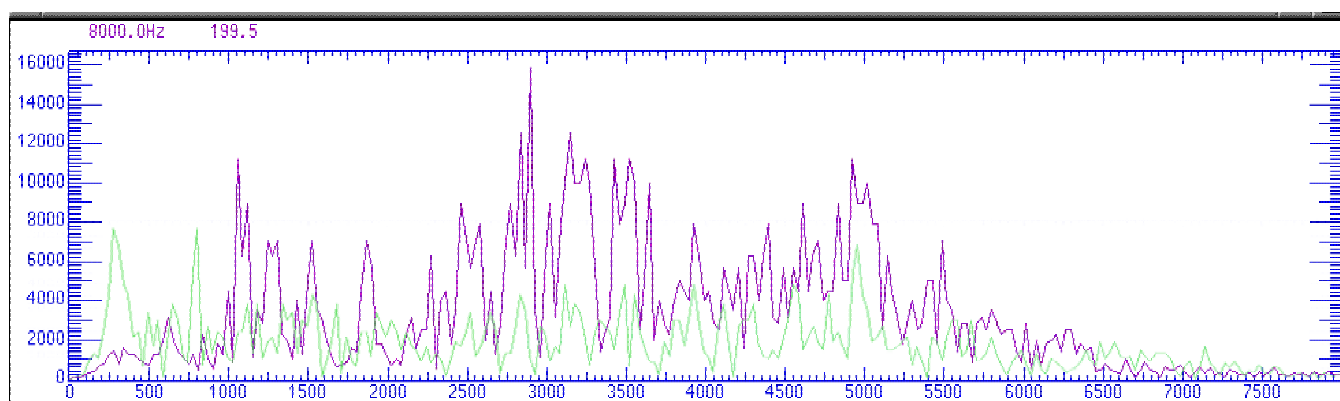

**Fig. 21: Comparaison des composantes fréquentielles entre les manettes poussées en position Flight Idle (en mauve) et en reverse (en vert). Spectrum comparison between the throttle set to Flight Idle position (in mauve) and Reverse position (in green)**

Les deux spectres présentent des caractéristiques générales proches ne permettant pas de distinguer les deux mouvements de manettes entre eux de manière systématique. Il convient donc de conclure que l'identification du bruit transcrit est **probablement celle d'un mouvement de manette, sans que l'on puisse conclure vers quelle position**. L'enregistrement FDR montre une montée en régime des moteurs

consécutives à ce bruit, ainsi que le passage du paramètre enregistrant le calage de l'hélice en « *Low Pitch* ». **Ce dernier point est cohérent avec l'hypothèse du passage en *Reverse*.**

*The two spectra show similar general characteristics, which makes it impossible to make a positive distinction between the two different lever movements in a systematic manner. It can thus be concluded that the identification of the transcribed noise is probably that of a thrust lever movement, though no conclusion can be reached as to which position it was moved to. The FDR recording shows an increase in engine RPM following this noise and the recorded parameter for the propeller pitch switches to "Low Pitch". This is consistent with the hypothesis of the Reverse mode of the propeller.*

**09 h 05 min 21 s : "Bruit similaire à la manoeuvre de la commande des flaps" / "Sound similar to the operation of flaps control"**

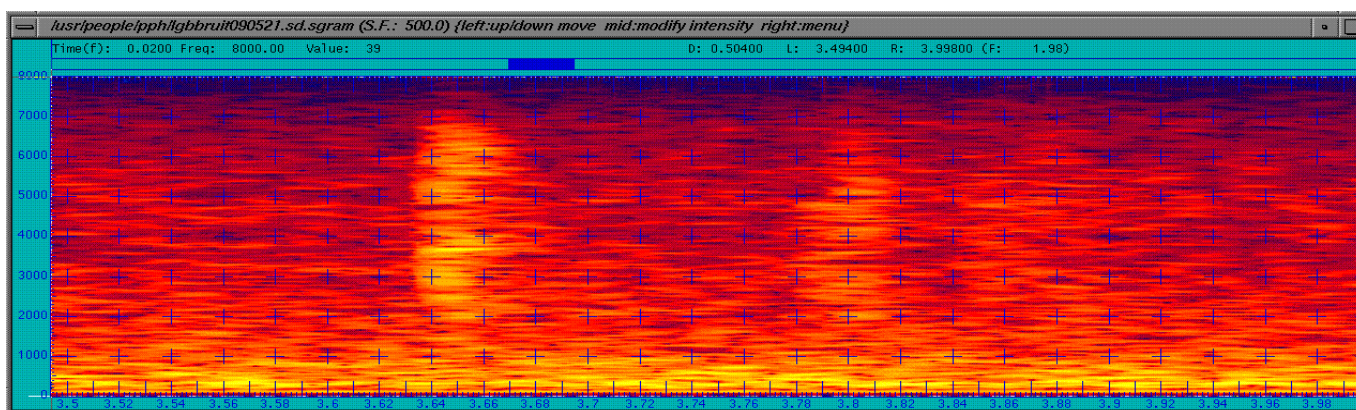

**Fig. 22 : Représentation Temps – Fréquence du bruit. Time – Frequency representation of the noise.**

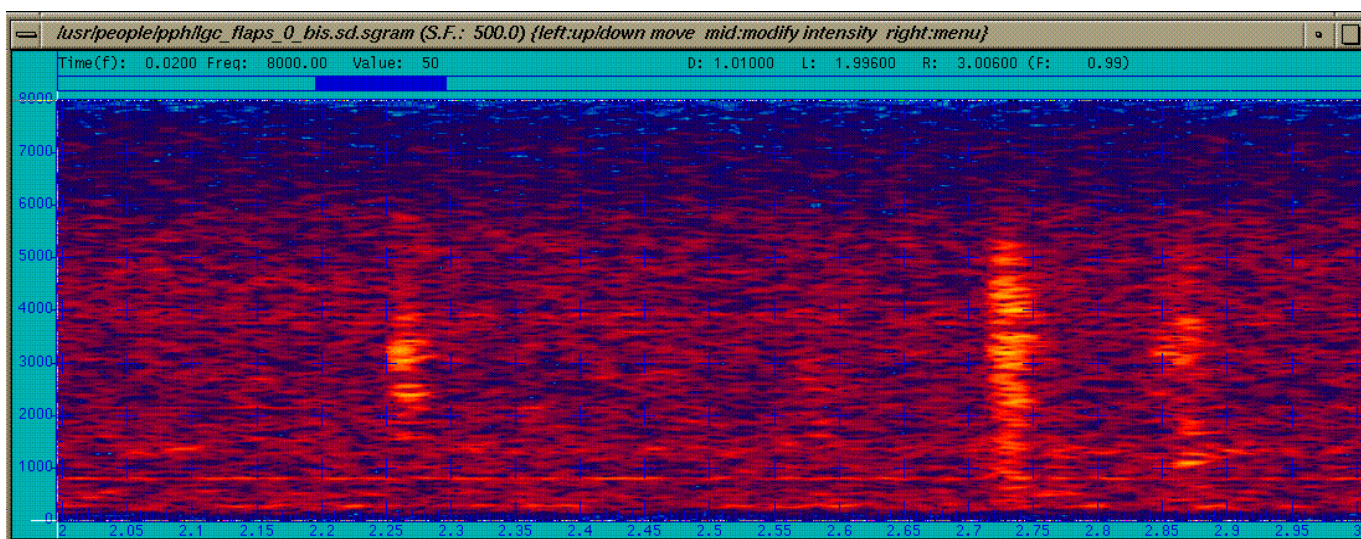
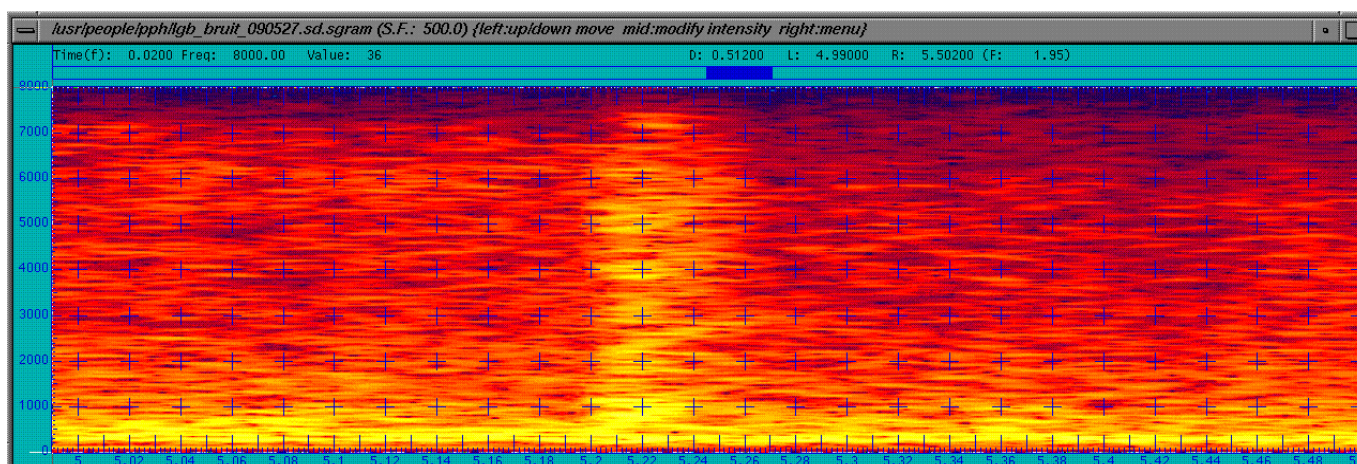

**Fig. 23 : Représentation Temps – Fréquence du bruit de la commande des volets ramenée en position 0°. Time – Frequency representation of the flaps command noise moved to 0°.**

Ce bruit intervient juste avant que les données FDR indiquent un repliement des volets vers la position « rentrés ». A l'écoute, ce bruit est perçu comme proche des bruits de commande des volets. Cependant, les essais effectués ne permettent pas de valider cette identification, les spectres de fréquence (non représentés ici) ne présentant que peu de similarités.

*This noise occurs just before the FDR data show that the flaps returned to the retracted position. When listening to this noise, it sounds similar to the noise of the flaps control. However, this could not be validated by the tests performed due to the small similarities between the frequency spectra (not represented here).*

**09 h 05 min 27 s : "Bruit" / "Noise"**



**Fig. 23 :** Représentation Temps – Fréquence du bruit. *Time – Frequency representation of the noise.*

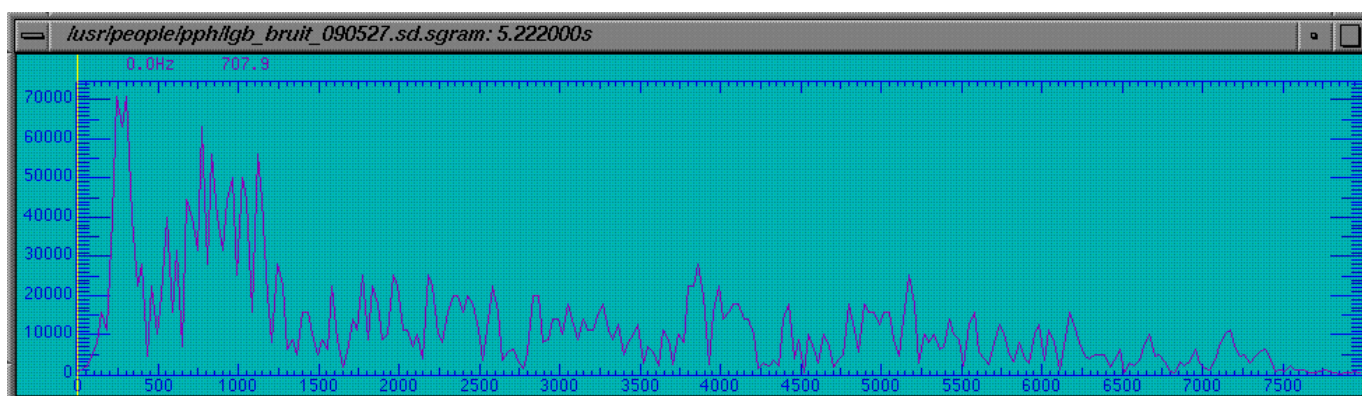

**Fig. 24 :** Spectre du bruit inconnu. *Spectrum of the unidentified noise.*

Ce bruit, caractérisé par de fortes énergies en basses fréquences, n'a pas pu être identifié par les essais.

*This noise, characterized by high levels of energy at low frequencies, could not be identified by the tests.*

## Conclusion

Les essais effectués sur deux Fokker 50 de la Luxair ont permis de recenser un grand nombre de bruits afin de les comparer à ceux présents sur le CVR du LX-LGB. Les outils disponibles pour ces identifications permettent de dégager certaines caractéristiques de ces bruits, comme leur durée, leur cadence et la répartition des fréquences majoritaires. Il convient lors de l'analyse de souligner que les essais ont été faits sur un avion de même type, mais différent de celui accidenté. Les bruits de fond peuvent varier avec la vitesse de l'avion, ses paramètres moteurs, sa configuration de vol (volets, pas de l'hélice, train d'atterrissage). De la même façon, chaque interrupteur ou manette d'un appareil peut présenter des caractéristiques propres différentes du même élément d'un autre avion.

Il ressort néanmoins de cette analyse les résultats suivants :

<b>Temps de la Transcription</b>	<b>Hypothèse</b>	<b>Résultat</b>
09 h 04 min 58s	Déplacement du Ground Idle Stop	Probable
09 h 05 min 00s	Soulèvement du Ground Range Selector	Positif
09 h 05 min 09s	Commande des flaps	Positif (vers 10 °)
09 h 05 min 11s	Activation des Taxi Lights	Positif
09 h 05 min 19s	-	Passage du cran ground idle (positive)
09 h 05 min 21s	Commande des flaps	Pas d'identification possible
09 h 05 min 27s	-	Pas d'identification possible

*The tests made on two Luxair Fokker 50's were used to compile a large number of noises in order to compare them to those recorded on LX-LGB. The tools available to identify them showed some characteristics of these noises, such as their duration, their rate and the main distribution of the frequencies. During analysis, it is important to note that the tests were recorded on the same type of aircraft, though different from the accident aircraft. Background noises may vary with the aircraft speed, its engine parameters, and flight configuration (flaps, propeller pitch, landing gear). Moreover, each switch or lever on the aircraft can have its own characteristics, different from those of the same part on another aircraft.*

*This analysis nevertheless gives the following results:*

<b>Time on the Transcription</b>	<b>Hypothesis</b>	<b>Result</b>
09 h 04 min 58s	Ground Idle Stop movement	Probable
09 h 05 min 00s	Lift of the Ground Range selector	Positive
09 h 05 min 09s	Flaps control	Positive (towards 10°)
09 h 05 min 11s	Taxi Lights switching on	Positive
09 h 05 min 19s	-	Noise of the ground idle position (positive)
09 h 05 min 21s	Flaps control	No identification possible
09 h 05 min 27s	-	No identification possible

Les autres bruits testés et décrits en page six n'ont pas de correspondance avec des bruits transcrits.  
*The other tested noises described in page six do not have any match with transcribed noises.*



## **Appendix 19**



LIMITATIONS  
POWER PLANT LIMITATIONS

2.06.01  
PAGE 3  
VERSION 05  
ISSUE 011

**FLEXIBLE TAKE-OFF (PROCEDURE)**

FLX shall not be used when:

- The runway is contaminated with standing water, slush, snow, or ice.
- The runway is wet unless the increased stopping distance is accounted for.
- Windshear is reported or expected.
- Skid control is inoperative.
- The operator cannot establish a means to verify the availability of max take-off power to ensure that engine deterioration does not exceed authorized limits.

**PROPELLER OPERATING LIMITS**

**WARNING: DO NOT ATTEMPT TO SELECT GROUND IDLE IN FLIGHT. IN CASE OF FAILURE OF THE FLIGHT IDLE STOP, THIS WOULD LEAD TO LOSS OF CONTROL FROM WHICH RECOVERY MAY NOT BE POSSIBLE.**

To avoid high propeller stresses, stabilized ground operation in the propeller rpm range of 65 per cent to 90 per cent NP is not permitted with the airplane static. Excluded from this limitation is the use of reverse during ground maneuvering in engine EC operating mode.

---

AFM FOKKER 50  
CAA-NL APPROVED

## **APPENDIX 20**

Transport and Water Management  
Inspectorate  
Civil Aviation Authority Netherlands



## Airworthiness Directive Of The Netherlands

Bijzondere Luchtwaardigheids Aanwijzing - BLA

Correspondence address  
P.O. Box 575, 2130 AN Hoofddorp, The Netherlands

### Caution

*In accordance with the Aviation Act 2001 (Wet Luchtvaart), Articles 3.22, the following Airworthiness Directive (BLA) is issued by the Minister of Transport, Public Works and Water Management. Airworthiness Directives affect aviation Safety. These are regulations which require immediate attention. You are cautioned that no person may operate an aircraft to which an Airworthiness Directive applies, except in accordance with the requirements of thereof*

BLA nr : 2003-091

Date : 31. juli 2003

**FOKKER SERVICES B.V.**  
(Fokker)

F.27 Mk.050, MK.502 AND MK.604

CAA-NL Type Certificate Nr.: T-050-87

### LANDING GEAR - SKID CONTROL UNIT – REPLACEMENT

#### Description :

Several Fokker 50 (F.27 Mk.050) operators have reported pulsating brake behaviour and loss of braking at low speeds in the normal braking mode. Investigation of this phenomenon has shown that electromagnetic interference (EMI), resulting from failed components in other electronic systems and induced on the wheel speed sensor and/or test inputs of the Skid Control Unit, is the cause of these problems. The Aircraft Braking Systems Corporation (ABSC) has now developed a modified Skid Control Unit, Part Number (P/N) 6004125-2 and has issued Service Bulletin (SB) 6004125-32-01 to recommend the replacement of all earlier models (P/N 6004125 and 6004125-1). Concurrently, this modified unit also provides suppression of the 20 mph wheel speed signals during the execution of a Skid Control Unit test in flight, which is recommended by the AOM, to be performed after a lightning strike with landing gear down. Suppression is considered necessary because the aforementioned signals inadvertently activate the Ground Control Relay and Flight-Idle Stop solenoid for about 16 seconds of the Propeller Control System. The modified unit retains the modification of P/N 600425-1 preventing inadvertent generation of the 20 mph wheel speed signals during power-up at landing gear extension. The conditions as described above, if not corrected, could result in continued erratic brake behaviour and propeller control problems. Since an unsafe condition has been identified that may exist or develop on aircraft of this type design, this Airworthiness Directive (BLA) requires the replacement of the affected Skid Control Units.

**Applicability:** Fokker Aircraft B.V., Model F.27 Mk.050, Mk.0502 and Mk.0604 aircraft, all serial numbers, if equipped with ABSC Skid Control Units P/N 6004125 or 6004125-1.

**Effective date :** September 1, 2003

**Compliance:** Required as indicated, unless accomplished previously.

- (a) Replace the affected Skid Control Units as follows
- (1) For Skid Control Units with P/N 6004125 (pre-ABSC SB F50-32-4), within the next 8 calendar months after the effective date of this directive, in accordance with Part 2 Accomplishment Instructions of Fokker Services SB F50-32-038 dated May 8, 2003 or a later CAA-NL approved revision; or
  - (2) For Skid Control Units with P/N 6004125-1 (post-ABSC SB F50-32-4), within the next 14 calendar months after the effective date of this directive, in accordance with Part Accomplishment Instructions of Fokker Services SB F50-32-038 dated May 8, 2003 or a later CAA-NL approved revision;

**Note:** ABSC SB No.6004125-32-01 dated May 7, 200 also pertains to this subject.

- (b) Before or concurrent with the action as required by either paragraph (a)(1) or (a)(2) of this directive, as applicable, modify the Skid Control Unit ground wiring in accordance with Part 2 Accomplishment Instructions of Fokker Services SB F50-32-035 dated August 2, 1999 or a later CAA-NL approved revision;
- (c) After May 1, 2004, no spare Skid Control Units P/N 6004125 or 6004125-1 may be installed as replacement parts.

#### Remarks

- Operators of the affected aircraft may obtain copies of the referenced service information upon request directly from Fokker Services B.V., Technical Services Dept., P.O.Box 231, 2150 AE Nieuw-Vennep, The Netherlands; telephone (31) 252-627-350; facsimile (31) 252-627-211; e-mail technicalservices.fokkerservices@stork.com.
- Compliance with this directive must be recorded in the proper Aircraft Log Book(s).

Address inquiries concerning this AD to  
Aircraft Division, Section C&D; telephone +31-23-566-3155; facsimile +31-23-566-3006; e-mail Info.Register@ivw.nl

## **APPENDIX 21**

**JAR-25**

JAR 25.1141(f) (continued)

(2) In the case of valves controlled from the cockpit other than by mechanical means, where the correct functioning of such a valve is essential for the safe operation of the aeroplane, a valve position indicator operated by a system which senses directly that the valve has attained the position selected, unless other indications in the cockpit give the flight crew a clear indication that the valve has moved to the selected position. (See ACJ 25.1141(f).)

[Ch.14, 27.05.94; Ch.15, 01.10.00]

**JAR 25.1143 Engine controls**

(a) There must be a separate power or thrust control for each engine.

(b) Power and thrust controls must be arranged to allow --

- (1) Separate control of each engine; and
- (2) Simultaneous control of all engines.

(c) Each power and thrust control must provide a positive and immediately responsive means of controlling its engine.

(d) For each fluid injection (other than fuel) system and its controls not provided and approved as part of the engine, the applicant must show that the flow of the injection fluid is adequately controlled.

(e) If a power or thrust control incorporates a fuel shut-off feature, the control must have a means to prevent the inadvertent movement of the control into the shut-off position. The means must --

- (1) Have a positive lock or stop at the idle position; and
- (2) Require a separate and distinct operation to place the control in the shut-off position.

[Ch.12, 10.05.88; Ch.13, 05.10.89]

**JAR 25.1145 Ignition switches**

(a) Ignition switches must control each engine ignition circuit on each engine.

(b) There must be means to quickly shut off all ignition by the grouping of switches or by a master ignition control.

Amendment 16

1-E-16

**SECTION 1**

JAR 25.1145 (continued)

(c) [ Each group of ignition switches except ignition switches for turbine engines for which continuous ignition is not required, and each master ignition control must have a means to prevent its inadvertent operation. ]

[Amdt. 16, 01.05.03]

**JAR 25.1149 Propeller speed and pitch controls**

(a) There must be a separate propeller speed and pitch control for each propeller.

(b) The controls must be grouped and arranged to allow --

- (1) Separate control of each propeller; and
- (2) Simultaneous control of all propellers.

(c) The controls must allow synchronisation of all propellers.

(d) The propeller speed and pitch controls must be to the right of, and at least one inch below, the pilot's throttle controls.

**JAR 25.1153 Propeller feathering controls**

(a) There must be a separate propeller feathering control for each propeller. The control must have means to prevent its inadvertent operation.

(b) If feathering is accomplished by movement of the propeller pitch or speed control lever, there must be means to prevent the inadvertent movement of this lever to the feathering position during normal operation.

**JAR 25.1155 Reverse thrust and propeller pitch settings below the flight regime**

[ Each control for selecting propeller pitch settings below the flight regime (reverse thrust for turbo-jet powered airplanes) must have the following:

(a) A positive lock or stop which requires a separate and distinct operation by the flight crew to displace the control from the flight regime (forward thrust regime for turbo-jet powered airplanes), and it must only be possible to make this separate and distinct operation once the control has reached the flight idle position.

(b) A means to prevent both inadvertent and intentional selection or activation of propeller pitch settings below the flight regime (reverse [

01.05.03

**SECTION 1****JAR-25**

JAR 25.1155(b) (continued)

[ thrust for turbo-jet powered airplanes) when out of the approved in-flight operating envelope for that function, and override of that means is prohibited.

(c) A reliability, such that the loss of the means required by paragraph (b) above is remote.

(d) A caution provided to the flight crew when the means required by paragraph (b) above is lost.

(e) A caution provided to the flight crew when a cockpit control is displaced from the flight regime (forward thrust regime for turbo-jet powered airplanes) into a position to select propeller pitch settings below the flight regime (reverse thrust for turbo-jet powered airplanes) outside the approved in-flight operating envelope. This caution need not be provided if the means required by paragraph (b) is a mechanical baulk that prevents movement of the control. ]

[Amdt. 16, 01.05.03]

**JAR 25.1161 Fuel jettisoning system controls**

Each fuel jettisoning system control must have guards to prevent inadvertent operation. No control may be near any fire extinguisher control or other control used to combat fire.

**JAR 25.1163 Powerplant accessories**

(a) Each engine-mounted accessory must

(1) Be approved for mounting on the engine involved;

(2) Use the provisions on the engine for mounting; and

(3) Be sealed to prevent contamination of the engine oil system and the accessory system.

(b) Electrical equipment subject to arcing or sparking must be installed to minimise the probability of contact with any flammable fluids or vapours that might be present in a free state.

(c) If continued rotation of an engine-driven cabin supercharger or of any remote accessory driven by the engine is hazardous if malfunctioning occurs, there must be means to prevent rotation without interfering with the continued operation of the engine.

[Ch.12, 10.05.88]

**JAR 25.1165 Engine ignition systems**

(a) Each battery ignition system must be supplemented by a generator that is automatically available as an alternate source of electrical energy to allow continued engine operation if any battery becomes depleted.

(b) The capacity of batteries and generators must be large enough to meet the simultaneous demands of the engine ignition system and the greatest demands of any electrical system components that draw electrical energy from the same source.

(c) The design of the engine ignition system must account for

(1) The condition of an inoperative generator;

(2) The condition of a completely depleted battery with the generator running at its normal operating speed; and

(3) The condition of a completely depleted battery with the generator operating at idling speed, if there is only one battery.

(d) *Not required for JAR -25.*

(e) No ground wire for any engine may be routed through a fire zone of another engine unless each part of that wire within that zone is fireproof.

(f) Each ignition system must be independent of any electrical circuit not used for assisting, controlling, or analysing the operation of that system.

(g) There must be means to warn appropriate flight-crew members if the malfunctioning of any part of the electrical system is causing the continuous discharge of any battery necessary for engine ignition.

(h) Each engine ignition system of a turbine powered aeroplane must be considered an essential electrical load.

[Ch.9, 30.11.82; Ch.14, 27.05.94]

**JAR 25.1167 Accessory gearboxes**

For aeroplanes equipped with an accessory gearbox that is not certificated as part of an engine -

(a) The engine with gearbox and connecting transmissions and shafts attached must be subjected to the test specified in JAR-E 160 and JAR E 740, as applicable.

## **Appendix 22**



One of the observations of the Luxair wreckage was that the right hand propeller blades were found in the maximum reverse pitch position. The internal examination of the right hand engine showed that there was no combustion at the time of impact, indicating that the engine was shutdown prior to that. Shutting-down the engine would normally result in a feathered or partly feathered propeller (depending on the available time) because the fuel lever also moves the feathering valve to the feather position.

Propeller hang-ups in reverse pitch may be explained by a phenomenon observed in the so-called "Cranbrook manoeuvre". The objective of the "Cranbrook manoeuvre" is to demonstrate that if full reverse thrust is selected after landing and the crew decides to take-off again because the runway is obstructed, that full forward thrust can be selected rapidly without exceeding any powerplant limitations. It should be noted that the "Cranbrook manoeuvre" is a special Canadian requirement (ref.: Airworthiness Manual Advisory AMA/525/3) that is not part of the standard JAR/FAR 25. During a recent Fokker 50 Type Validation meeting with Transport Canada it was stated that the Fokker 50 would not be required to meet this requirement because of the original Type Certification date of the Fokker 50 was before the AMA 525 publication date.

From "Cranbrook manoeuvre" type testing it is known that, when slamming a power lever from full reverse to above flight idle, occasionally the propeller may not come out of reverse and may not get into feather either. This behavior requires a real slamming movement and can not be duplicated in case of a more gradual power lever movement. The phenomenon (which may be expected to be common for similar turboprop designs) can be explained as follows.

There are two means to move the propeller blades from the reverse position towards the take-off position (coarse pitch), hydraulically when the propeller is beta controlled or by means of counter weights in the constant speed range. Which of the two means applies depends on the power lever position, i.e. below flight idle this will be hydraulic pressure and above flight idle the counter weights. The counter weights will only force the propeller blade to the correct (coarse) direction from a positive blade angle as starting point.

The reverse pitch hang-up will occur when the power lever is moved out of the full reverse position into a position above the flight idle so quickly that the propeller blade has no time to achieve a positive blade angle. This because, if the blade angle is still negative when the oil pressure is dumped, the counter weights may return the blades to the full reverse position.

In addition with subsequent fuel shutoff, feathering is also not possible when the propeller is in the full reverse position and the power lever in the flight range because the relevant ports in the pitch control unit are blocked.

The Luxair FDR data for the right hand engine has been reviewed to determine if the reverse pitch hang-up could have been caused by an "in flight Cranbrook type manoeuvre". One significant phenomenon that is noticeable on the FDR is that when the propeller has entered beta range both propeller speed (Np) and high pressure rotor speed (Nh) increase. The increase of propeller speed in that case is expected due to the windmilling effect. However, the Engine Electronic Control (EEC) should have reduced the fuel flow to minimum idle in an attempt to lower the propeller speed to the correct Np speed schedule in the EEC. Furthermore, the propeller overspeed appears to be controlled at 108 percent, which indicates that fuel flow is not controlled by the EEC but instead by the overspeed governor (pneumatic setting). Shop testing of the fuel system components afterwards did not show any defects that could explain this uncontrolled fuel flow after beta entry.

If however the power lever is assumed to be in the flight range, i.e. above flight idle, while the propeller pitch is at maximum reverse, the EEC will control engine power regardless of propeller speed. When the propeller speed reaches the set point of the overspeed governor, the overspeed governor will limit the fuel flow. This scenario exactly matches the recorded data.

The Fokker logo is a stylized, handwritten-style script of the word "Fokker" in black ink, with a thin underline beneath the letters.

---

**STORIK®**

Fokker Services B.V.

---

Assuming that the crew operated both power levers simultaneously, it can be concluded that both power levers were far in the reverse range and that both were slammed forward. The FDR shows that both propellers were below the low pitch switch setting when the FDR stopped. On the ground however the LH propeller was found in the feather position while the RH propeller was found in reverse position. This indicates that the blade angle/beta tube positions on both propellers were marginal with respect to the ability to feather (apparently leading to the situation where the LH pitch control mechanism just received supply of feathering pump oil pressure, and the RH side not).

Had this phenomenon not occurred on the RH engine/propeller, thus assuming RH propeller had feathered after the last recorded sample as well, this would eventually have taken away the asymmetry, but would of course (given the shutdown of both engines) not have restored propulsion.

The Fokker logo is a stylized, handwritten-style script of the word "Fokker" in black ink, with a horizontal line underneath the letters.